

CHECK VALVES



CHECK VALVES

531 CHECK VALVE | 1/2# cracking pressure | Patented

Features:

- The mating pipe cannot block the valve from operating
- Longer threads make for an excellent valve when used with PVC pipe
- The Celcon guide compresses into the valve body preventing the valve from coming apart during operation
- Celcon guide and poppet manufactured from same materials for longer wearability
- Square hole in Celcon guide prevents grit retention, eliminates wear
- Celcon bullet shaped poppet for smooth flow, excellent for VFD pumps
- Tapered seat washes clean
- Coined seat for smooth hardened surface
- The seat I.D. is the same as the mating pipe I.D. - a full flow valve 40-60% greater flow than industry standard
- For vertical use
- All of these features are contained in a water works grade 81 Red Brass body
- Excellent for hot water heat systems; rated at 180 degrees
- Lead Free: ≤ .025% Lead Content

Part Number	Size (Inches)	Weight (lbs)	Quantity/Carton	List Price Each
922823	1	0.8	25	See separate price list
922824	1-1/4	1.3	25	
922825	1-1/2	1.6	IND.	
922826	2	2.8	IND.	

- Female x Female In-line Check

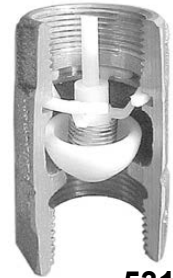

531

529 CHECK VALVE | 1/2# cracking pressure | Patented

- Lead Free: ≤ .025% Lead Content

Part Number	Size (Inches)	Weight (lbs)	Quantity/Carton	List Price Each
922605	1 x 1	0.8	25	See separate price list
922606	1-1/4 x 1	0.9	25	
922607	1-1/4 x 1-1/4	1.2	25	
922608	2 X 2	2.6	IND.	

- Male x Female In-line Check (pump head use)



529

529 XLT CHECK VALVE | Patented

Features:

- Designed for special Bell Socket PVC Drop Pipe
- Lead Free: ≤ .025% Lead Content

Part Number	Size (Inches)	Weight (lbs)	Quantity/Carton	List Price Each
922700	1	1.0	25	See separate price list
922702	1-1/4	1.5	25	
922704	2	3.3	IND.	

- Male x Female



529XLT

530 CHECK VALVE | 1# cracking pressure

Features:

- Heavy red brass body for maximum strength
- Spool type brass poppet eliminates sticking
- Buna-n rubber facing for water, oil or gas
- Silent operation in horizontal or vertical position
- Can be used with water, oil or gas
- Lead Free: ≤ .025% Lead Content

Part Number	Size (Inches)	Weight (lbs)	Quantity/Carton	List Price Each
922579	1/2	0.6	25	See separate price list
922582	3/4	1.2	25	
922585	1	1.5	25	
922588	1-1/4	1.8	25	
922591	1-1/2	2.5	IND.	
922594	2	3.8	IND.	
922597	2-1/2	7.0	IND.	
922600	3	13.0	IND.	
922603	4	38.0	IND.	

- Female x Female In-line Check

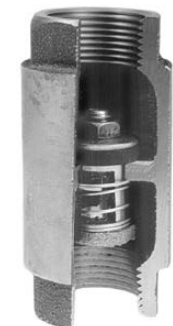

530

Note: All brass foot and check valves rated at 200 psi at 180°F operating temperature.

CHECK VALVES

CHECK VALVES
DUCTILE IRON CHECK VALVES



536-S

536-S TAPPED CHECK VALVE

- Features:
- One 1/8" hole for 645 air valve on inlet side
 - Lead Free: ≤ .025% Lead Content

Part Number	Size (Inches)	Weight (lbs)	Quantity/Carton	List Price Each
922655	1	0.8	1.5	See separate price list
922656	1-1/4	0.9	2.0	
922657	1-1/2	1.2	3.0	
922660	2	2.6	4.0	

- Female x Female Check



538-S

538-S TAPPED CHECK VALVE

- Features:
- One 1/8" hole for 645 air valve on inlet side
 - One 1/4" hole for pressure switch on outlet side
 - Lead Free: ≤ .025% Lead Content

Part Number	Size (Inches)	Weight (lbs)	List Price Each
922687	1	1.5	See separate price list
922690	1-1/4	2.0	
922693	1-1/2	3.0	
922694	2	4.0	

- Female x Female Check



539-S

539-S TAPPED CHECK VALVE

- Features:
- Two 1/4" holes - 90° apart on outlet side
 - Lead Free: ≤ .025% Lead Content

Part Number	Size (Inches)	Weight (lbs)	List Price Each
922715	1	1.5	See separate price list
922716	1	2.0	

- Female x Female Check

DUCTILE IRON CHECK VALVES

600 SPRING LOADED CHECK VALVE

Features:

- Ductile iron body
- Stainless steel spring and nut
- Lead free ($\leq 0.25\%$ lead content)
- Powder coated finish
- Silicone bronze poppet

Part Number	Size (Inches)	Weight (lbs)	List Price Each
922795	6	40.0	See separate price list
922796	8	54.5	See separate price list

- Female x Female Inline Check



600

600 SPRING LOADED CHECK VALVE WITH BREAK OFF PLUG

Features:

- Include 1/2" stainless steel break off plug

Part Number	Size (Inches)	Weight (lbs)	List Price Each
922797	6	40.5	See separate price list
922798	8	55.5	See separate price list

- Female x Female Inline Check



Break Off Plug Only

BREAK OFF PLUG ONLY

Features:

- Includes 1/2" stainless steel as standard

Part Number	Size (Inches)	Weight (lbs)	List Price Each
922561	1/2	0.50	See separate price list

630 SPRING LOADED CHECK VALVE

Features:

- Designed for VFD systems
- Stainless steel spring and nut
- Ductile Iron body
- Stabilizer sleeve increases contact area
- Lead free ($\leq 0.25\%$ lead content)
- 600 PSI working pressure

Part Number	Size (Inches)	Weight (lbs)	List Price Each
922800	3	11.7	See separate price list
922801	4	21.5	
922802	5	44.4	
922803	6	60.2	

- Female x Male



630

FOOT VALVES

FOOT VALVES



534

534 FOOT VALVE

Features:

- Heavy red brass body
- Brass spool type poppet
- Brass screen strainer
- Rubber facing for water, oil and gas
- Lead free ($\leq 0.25\%$ lead content)

Part Number	Size (Inches)	Size of Pipe Valve Fits Inside	Weight (lbs)	List Price Each
922747	1	1-1/2	0.8	See separate price list
922750	1	2	1.0	



634

634 FOOT VALVE

Features:

- Heavy red brass body
- Brass O-ring type poppet
- Stainless steel screen strainer
- Lead free ($\leq 0.25\%$ lead content)

Part Number	Size (Inches)	Weight (lbs)	List Price Each
922776	3/4	0.53	See separate price list
922777	1	0.74	
922778	1-1/4	1.26	
922779	1-1/2	1.50	
922780	2	2.72	
922782	3	9.00	
922789	4	16.50	
922790	6	35.00	



540

540 FOOT VALVE

Features:

- Cast iron body and strainer
- Leather flapper check
- Open area of strainer exceeds pipe area
- Tapped IPS
- Use for irrigation or drainage or effluent

Part Number	Size (Inches)	Weight (lbs)	Quantity/Carton	List Price Each
931671	2	PTD	5.5	See separate price list
931673	3	PTD	10.8	
931674	4	PTD	19.5	
931676	6	PTD	47.0	



500

500 FOOT VALVE (Strainer Only)

Features:

- Reduces inventory - can be used on any female tapped check valve
- Strainer made of plastic

Part Number	Size (Inches)	Weight (lbs)	List Price Each
542750	1	0.1	See separate price list
542755	1-1/4	0.1	



FV4-1

FV4-1 FOOT VALVE

Features:

- Manufactured from Delrin™

Part Number	Size (Inches)	Weight (lbs)	List Price Each
922860	FV4-1	Fits 3/4" to 1 1/2" pipe size	See separate price list

CYCLE SLAYER PUMP STOP VALVES

Features:

- Controls pump cycling, reducing amount of electricity used by the pump
- Eliminates early pump failure and reduces pump cycling, increasing the life of pumps
- Reduces the size of pressure tank necessary
- Adjustable bypass valves easily control run-time
- Prevents and controls water hammer

PLASTIC FIXED PRESSURE SERIES

Features:

- 1" valve can be used in 4" or larger well
- Preset to 50 psi
- 1/4" valve can be used in 5" or larger well
- Tank fill rate 2.95 gpm
- Lead free ($\leq 0.025\%$ lead content)
- Thermoplastic construction

Friction Loss Data, Plastic Models: Flow Rates - GPM/Gallons per Minute

Part Number	Model	Size	Preset	5	10	15	20	30	40	50	60	85	100	List Price Ea.
935822-40	PS-100P	1"	40 PSI	3.36	2.60	1.822	2.35	5.40						See separate price list
935822-50	PS-100P	1"	50 PSI											
935822-60	PS-100P	1"	60 PSI											
935824-40	PS-125P	1-1/4"	40 PSI				3.04	2.66	2.33	2.97	4.14	5.62		

IN-WELL COUPLING ADAPTOR

Part Number	Model	Size	Description	List Price Each
935826	PS-WC	1"	Well Couping Adaptor	See separate price list
935828	PS-WC	1-1/4"	Well Couping Adaptor	

BRASS SERIES

Features:

- Bronze or stainless steel body
- Double union inlet and outlet construction
- Thermoplastic seat
- By-pass feature controls expansion pressure
- Sealed spring cage for accessible outdoor installations
- Lead free ($\leq 0.25\%$ lead content)
- Metal cage

Friction Loss Data, Plastic Models: Flow Rates - GPM/Gallons per Minute

Part No.	Model	Size/Description	5	10	15	20	30	40	50	60	85	100	List Price Ea.
935812	PS100B-1	1"/Adj. 25-75 PSI		7.5		13	22						See separate price list
935814	PS125B-1-1/4	1-1/4"/Adj. 25-75 PSI		6		7.5	9	11	13	16	21		
935834	PS100B-1	Adj. 20-90 PSI											
935836	PS125B-1-1/4	Adj. 20-90 PSI											
935838	PS200B-2	Adj. 20-90 PSI											

STAINLESS SERIES

Features:

- Stainless steel cage
- Lead free ($\leq 0.025\%$ lead content)

Part Number	Model	Type	List Price Each
935832	PS-100SS-1	1" / Adj. 20-90 PSI	See separate price list

CAST IRON SERIES

Features:

- Adjustable by-pass
- Bronze body construction
- Field serviced without removal of valve
- Liquid-filled stainless steel gauge
- Adjustable 25-85 PSI
- Stainless steel control lines
- Lead free ($\leq 0.025\%$ lead content)

Friction Loss Data, Plastic Models: Flow Rates - GPM/Gallons per Minute

Part No.	Model	Size	Type	30	40	60	80	100	200	400	600	800	1000	List Price Ea.
935802	PS-200 CI	2"	Globe	.2	.33	.7	1.22	2.0	8.0					See separate price list
935804	PS-300 CI	3"	Globe			1.22	.2	.3	1.2	5.0	12.0	18.0		
935806	PS-400 CI	4"	Globe						4.0	4.0	8.0	15.0	24.0	



dicken™ PITLESS ADAPTERS



Features:

- Precision machined all red brass castings with neoprene O-ring
- Large inner and outer rubber gaskets to seal out surface water contamination
- All Dicken pitless adapters are pressure tested to 150 psi
- Chamfered slide for fast and easy installation
- Wrench grip on ell speeds installation
- A built in lowering eyelet for easier installation
- Water System Council - PAS-97 (2012) listed
- Lead Free: ≤ .025% Lead Content



Part Number	Model	Discharge Pipe (Inches)	Supply Pipe (Inches)	Casing Size (Inches) I.D.	Hole Size Required (Inches)	Shipping Weight (lbs-oz.)	Working Load (lbs.)	Quantity /Carton
952156	JR-S-10	1	1	4-1/2 to 12	1 5/8	2 lbs. 5 oz.	1500	12
952158	*JR-S-10-P	1	1	4-1/2 to 12	1 5/8	2 lbs. 5 oz.	1500	12
952110	LD-S-10	1	1	5 to 12	1-3/4	4 lbs. 2 oz.	2000	12
952160	*LD-S-10-P	1	1	5 to 12	1-3/4	4 lbs. 3 oz.	2000	12
952112	LD-S-12	1-1/4	1-1/4	5 to 12	2-1/4	5 lbs. 8 oz.	2000	8
952162	LD-S-12-P	1-1/4	1-1/4	5 to 12	2-1/4	5 lbs. 9 oz.	2000	8
952010	S-10	1	1	5 to 12	1-3/4	5 lbs.13 oz.	5000	8
952012	S-12	1-1/4	1-1/4	5 to 12	2-1/4	8 lbs. 2 oz.	5000	6
952015	S-15	1-1/2	1-1/2	5-3/16 to 12	2-5/8	10 lbs.12 oz.	5000	6
952016	S-15P	1-1/2	1-1/2	5-3/16 to 12	2-5/8	10 lbs.12 oz.	5000	6
952020	S-20	2	2	5-5/8 to 12	3-1/8	14 lbs. 4 oz	5000	4
952150	LD-2-X upper	1-1/4	1-1/4	4-1/2 to 12	2-1/4	11 lbs. 9 oz.	2000	6
	LD-2-X lower	1	1		1-3/4			

- Pressurized model available for counties and states where required.
- JR-S-10 may be used on 4" casing with 3" pump.
- NOTE: Part Number 952015 Model S-15 not designed for STR17 5" PVC casing.

CLEARWAY PITLESS ADAPTER | Patented

Features:

- Simple slip fit insert
- Easy installation by cutting 2 3/4" hole and clamping on
- Clamp on units for no obstruction in well casing ID
- Lead Free: ≤ .025% Lead Content



Part Number	Model	Discharge Pipe (Inches)	Supply Pipe (Inches)	Casing Size (Inches) I.D./O.D.	Hole Size Required (Inches)	Shipping Weight (lbs-oz.)	Working Load (lbs.)	Quantity /Carton
952040	CW-4-10	1	1	4 4-1/2	2-3/4	5 lbs. 1 oz.	2000	6
952050	CW-5-10	1	1	4-1/2 5	2-3/4	5 lbs. 0 oz.	2000	6
				5 5-9/16				
952060	CW-6-10	1	1	6 6-5/8	2-3/4	5 lbs. 14 oz.	2000	6
952045	CW-4-10-WA	1	1	4 4-1/2	2-3/4	6 lbs. 0 oz.	2000	6
952047	CW-4.5-10-WA	1	1	4-1/2 5	2-3/4	6 lbs. 8 oz.	2000	6
952055	CW-5-10-WA	1	1	5 5-9/16	2-3/4	6 lbs. 8 oz.	2000	6
952065	CW-4-12-WA	1-1/4	1-1/4	4 4-1/2	2-3/4	6 lbs. 5 oz.	2000	6
952066	CW-4.5-12-WA	1-1/4	1-1/4	4-1/2 5	2-3/4	6 lbs. 12 oz.	2000	6
952067	CW-5-12-WA	1-1/4	1-1/4	5 5-9/16	2-3/4	6 lbs. 5 oz.	2000	6
952058	CW-6-12-WA	1-1/4	1-1/4	6 6-5/8	2-3/4	6 lbs. 15 oz.	2000	6

DICKENS PITLESS ADAPTERS

MAASS™ PITLESS ADAPTERS



MAASS MODEL J SERIES OF PITLESS ADAPTER AND UNITS ALL FEATURE:

- Water contacts only 304 stainless steel and brass, eliminates rust, corrosion, and electrolysis in the adapter
- Durable cast steel housing
- Tapered 8° slip fitting for easy installation and removal of brass insert
- No obstruction left in well casing when brass insert is pulled
- Designed for shallow or deep settings and high working pressures
- Water System Council - PAS-97 (2012) listed
- Lead Free: ≤ .025% Lead Content

MAASS MODEL J SERIES ALL WETTED PARTS WELD ON PITLESS ADAPTERS

Features:

- 304 Stainless Steel
- Made in the USA
- Assembled with foreign and domestic components

Part Number	Model	Discharge Pipe (Inches)	Drop Pipe (Inches)	I.D. Casing Size (Inches)	Weight (Lbs.)	Working Load (lbs.)	List Price Each
928100WS	4J1 WS	1	1	4-5	6.0	4000	See separate price list
928105WS	4J1-1/4 WS	1-1/4	1-1/4	4-5	7.0	5000	
928120WS	6J1 WS	1	1	6-7-8+	6.0	4000	
928125WS	6J1-1/4 WS	1-1/4	1-1/4	6-7-8+	7.0	5000	
928135WS	6J2 WS	2	2	6-7-8 +	12.0	6000	



MAASS™ PITLESS ADAPTERS

MAASS MODEL J WELD-ON PITLESS ADAPTER | Patented

Features:

- Permanently installed by welding for increased strength and durability
- J Series of adapters and units available with stainless steel, nickel-bronze inserts, stainless steel housings, and viton or teflon O-rings
- Only two one inch outlet size Model J Pitless needed to fit all well casing sizes

Part Number	Model	Discharge Pipe (Inches)	Drop Pipe (Inches)	I.D. Casing Size (Inches)	Weight (Lbs.)	Working Load (lbs.)	List Price Each
928100	4J1	1	1	4-5	6.0	4000	See separate price list
928105	4J1 1/4	1-1/4	1-1/4	4-5	7.0	5000	
928110	4J1 1/2	1-1/2	1-1/2	4-5	8.5	5000	
928115	5J2	2	2	5	12.0	6000	
928120	6J1	1	1	6-7-8+	6.0	4000	
928125	6J1 1/4	1-1/4	1-1/4	6-7-8+	7.0	5000	
928130	6J1 1/2	1-1/2	1-1/2	6-7-8+	8.5	5000	
928135	6J2	2	2	6-7-8+	12.0	6000	
928140	6J2 1/2	2-1/2	2-1/2	6-7-8+	18.0	8000	
928145	8J3	3	3	8-10-12+	32.0	10000	
928150	10J4	4	4	10-12-14+	50.0	15000	



MAASS MODEL JJ WELD-ON PITLESS ADAPTER FOR SUCTION PUMPS | Patented

Features:

- Lateral (2") can be pressurized to meet state codes
- Wisconsin and Michigan State approved

Part Number	Model	Discharge Pipe (Inches)	Drop Pipe (Inches)	I.D. Casing Size (Inches)	Weight (Lbs.)	Working Load (lbs.)	List Price Each
928200	4JJ1	1	2	4-5	13.0	4000	See separate price list
928205	6JJ1	1	2	6-7-8	13.0	4000	
928210	4JJ1 1/4	1-1/4	2	4-5	14.0	5000	
928215	6JJ1 1/4	1-1/4	2	6-7-8	14.0	5000	



MAASS™ PITLESS UNITS

MODEL JX1 - PITLESS BURY UNITS | Patented

Features:

- Maass pitless units constructed of schedule 40 steel pipe
- Maass pitless units are Wisconsin, New York, Illinois and Michigan approved
- JX1 Unit meets Great Lakes and Upper Mississippi River Board of State Public Health and Environmental Managers Standards.
- JX1 Units can come threaded or plain end for welding
- Specify bury depth when ordering JX1 Pitless Units
- PA Option and PSP Package available on 1" discharge models for pressure switch in the well in 5" or larger casing
- JX1 units have standard male threads for attachment at base
- Lead Free: ≤ .025% Lead Content

MAASS PITLESS UNITS



Part Number	Model Number/Model	Well Casing Size	Water Outlet & Drop Pipe Size	List Price
928500	4JX1-1	4	1	See separate price list
928505	4JX1-1 1/4	4	1-1/4	
928510	4JX1-1 1/2	4	1-1/2	
928515	5JX1-1	5	1	
928520	5JX1-1 1/4	5	1-1/4	
928525	5JX1-1 1/2	5	1-1/2	
928530	5JX1 - 2	5	2	
928535	6JX1-1	6	1	
928540	6JX1-1 1/4	6	1-1/4	
928545	6JX1-1 1/2	6	1-1/2	
928550	6JX1-2	6	2	
928555	6JX1-2 1/2	6	2-1/2	
928560	8JX1-1	8	1	
928565	8JX1-1 1/4	8	1-1/4	
928570	8JX1-1 1/2	8	1-1/2	
928575	8JX1-2	8	2	
928580	8JX1-2 1/2	8	2-1/2	
928585	8JX1-3	8	3	
928590	10JX1-2	10	2	
928595	10JX1-2 1/2	10	2-1/2	
928600	10JX1-3	10	3	
928605	10JX1-4	10	4	

- **NOTE: Other sizes and combinations of JX1 Pitless Units are available.**
- **JX1 units allow 12" above grade stick-up beyond bury depth - check local codes.**

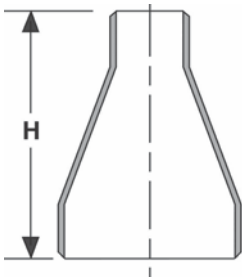

CONCENTRIC REDUCERS

Feature:

- Fittings conform physically and chemically to ASTM Specification A106

Part Number	Size	Height (H)	Standard Weight	List Price
003325	8" x 6"	6"	13 1/4 lbs.	See separate price list
003326	10" x 8"	7"	22 lbs.	

MAASS™ MODEL MB PITLESS UNIT

Features:

- Designed for ease and convenience in setting and pulling pumps
- For 8, 10, 12, 14, 16, 18, 20, 22, 24 inch and larger wells
- Available with 2" through 14" discharge and spool pipe
- Standard features include stainless steel inserts used at critical "O" Ring Seal and Spool Seat Surfaces
- Vertical turbine and booster pump station units and flow meters available
- All MB Units coated inside and outside with FDA & NSF approved 2 part catalytic epoxy meeting AWWA C-210 standard
- Meets Great Lakes and Upper Mississippi River Board of State Public Health and Environmental Managers standards
- Available with all wetted parts made of stainless steel
- Lead Free: ≤ 0.25% Lead Content

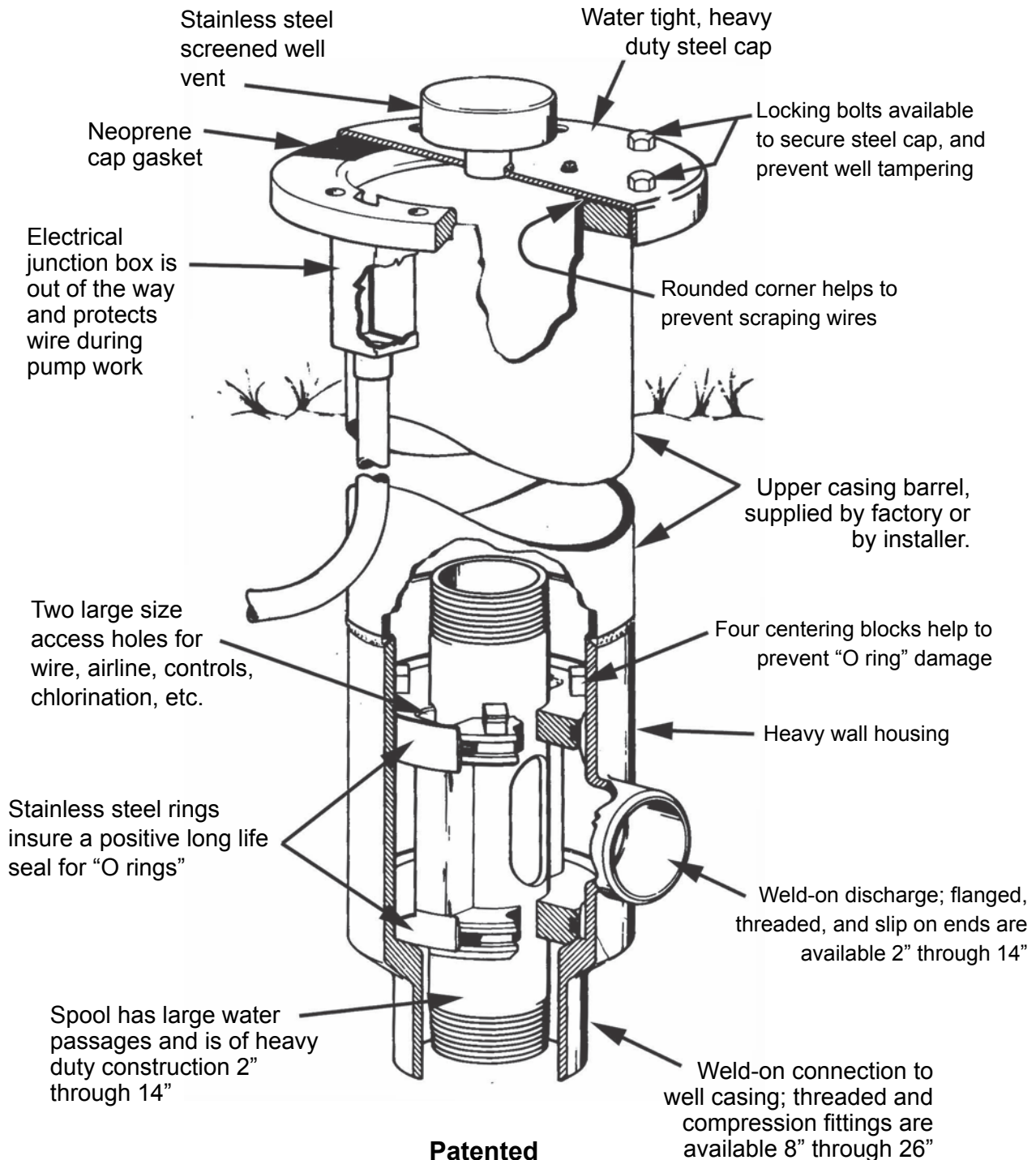

MAASS MODEL MB
PITLESS ADAPTER

MAASS™ MODEL MB PITLESS UNIT

MODEL NUMBER ORDERING GUIDE

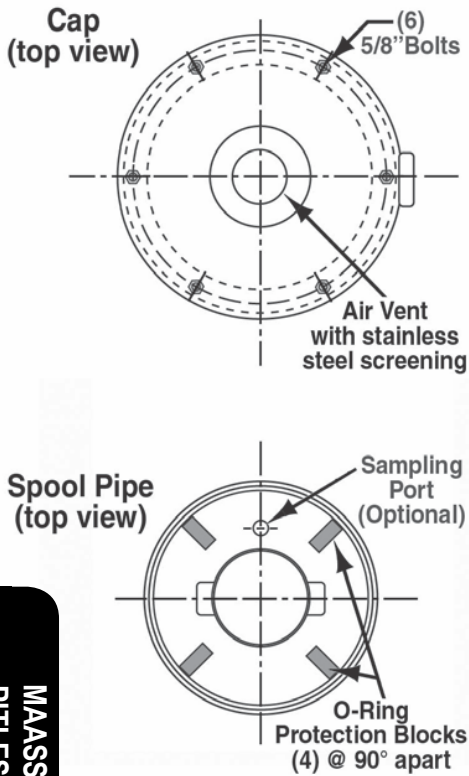

MODEL	MB
	Heavy Duty = (HD), Extra Heavy Duty = (XHD) with APIR Threads
	Submersible = (S), Booster Station = (B), Turbine = (T)
HOUSING	Casing Diameter = (8" - 36")
	Upper Barrel Diameter (10" - 38")
	Discharge Diameter (2" - 14")
	Discharge Type Male Thread = (MT), Female Thread = (FT), Plain End = (P), Flanged = (F)
SPOOL	Pump Pipe (2" - 14")
	National Pipe Thread = (NPT), APIR Round = (APIR)
CAP	Well Cap - Watertight = (WT), Aluminum = (AL), Watertight Aluminum = (AWT)
OPTIONS	Bury Depth (if upper casing is ordered)
	Custom Features (Please describe) (See Options)

MODEL	WELL CASING					
Heavy Duty (HD)	8"	10"	12"	14"	16"	18" or larger
Pump Column Discharge Pipe						
Standard	4"	6"	6"	6"	6"	6"
Optional	2", 3", 4"	4", 5"	4", 5"	4", 5", 8"	5", 8", 10"	5", 8", 10", 12"

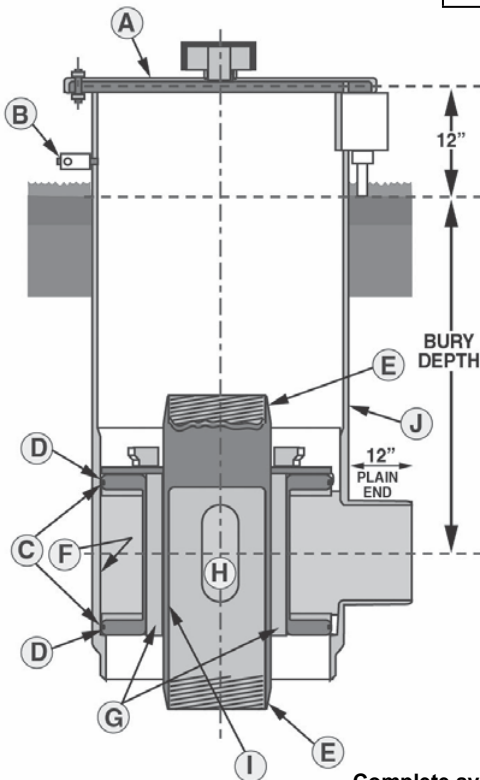

- A - Steel watertight cap shown for Heavy Duty Units. Cast Aluminum watertight or submersible cap available.
- B - Airline Test Block - Optional.
- C - 304 Stainless Steel rings and seat standard.
- D - O-Rings - 3/8" cross section.
- E - Male NPT threads on spool pipe, API threads or Flanges optional.
- F - Heavy Duty Units have 1/2" or thicker housing wall.
- G - Large access channels, Stainless Steel tubes for seal wire connections or flowing well available.
- H - Spool discharge openings 100% or greater than spool pipe used.
- I - Spool Pipe XS wall.
- J - Upper casing barrel 3/8" thick.

OPTIONS:

- CD = Chlorinator Discharge
- FM = Flow Meter
- SWC = Sealed Wire Connections
- BPS = Booster Pump Stations
- ATB = Airline Test Blocks
- CVS = Check Valve in Spool
- LB = Locking Bolts
- TA = Torque Arrestor and Lift-Out Bail HDR = Hold Down Ring
- RT = Restraining Tabs
- Other options, please describe

Complete systems include Maass Midwest Control Panel

OPTIONS: Chlorinator discharge; Flow Meters; Airline Test Blocks; Turbine Pump mountings and seals; Sealed wire connections in spool for Flowing Wells and Booster Pump Stations; Check valve in spool; Locking bolts for well cap; Torque Arrestor & Lift-out bail.

***ALL STAINLESS STEEL AND ALL WETTED PARTS ADAPTERS AVAILABLE UPON REQUEST.**

MAASS MODEL MB
PITLESS ADAPTER

MAASS MIDWEST SELECTION GUIDE ENGINEER QUESTIONS | ANSWER PAGE

System Information

Total Dynamic Head:	Phase:
Required Flow Rate:	Voltage:
Inlet Suction Pressure (PSI):	FLA:
Desired Discharge Pressure (PSI):	SFA:
Inlet Suction Pipe Diameter (Booster Only):	Choose a NEMA Rating: NEMA 3R Outdoor Enclosure <input type="checkbox"/>
Discharge Pipe Diameter:	NEMA 1 Outdoor Enclosure <input type="checkbox"/>

TYPICAL APPLICATIONS

Maass Midwest Well/Storage Tank/Simplex & Duplex Constant Pressure

1. Simplex/Duplex VFD Panel - Constant Pressure
2. Well Pump Panel (Optional)
3. Well Pump
4. Storage Tank
5. Booster Pumps
6. Schneider Pressure Transducers - Suction & Discharge
7. Unimax Float Switches - Level Controls (Optional)

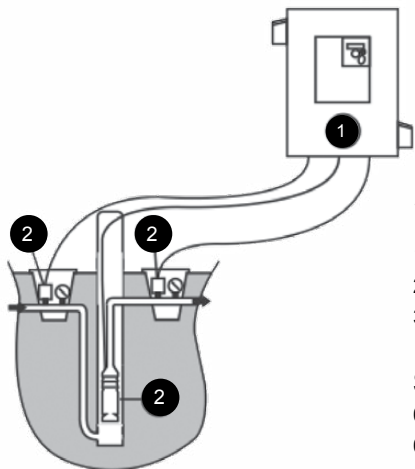
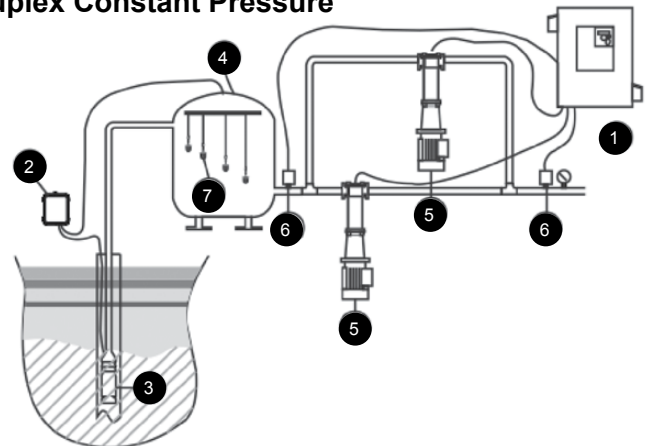

Maass Midwest Booster/Rural Water/ Water Pressurization Systems

1. Simplex VFD Panel
2. Booster Pump
3. Schneider Pressure Transducers - Suction & Discharge

Schneider Pressure Transducers

- 0-100 PSI
- 0-150 PSI
- Other configurations available.

MAASS SELECTION GUIDE
VFD BOOSTER & PUMP PANELS

VFD BOOSTER AND SUBMERSIBLE PUMP PANELS

Standard controls from 3HP - 250HP

Custom Controls above 250 HP - consult factory



SIMPLEX

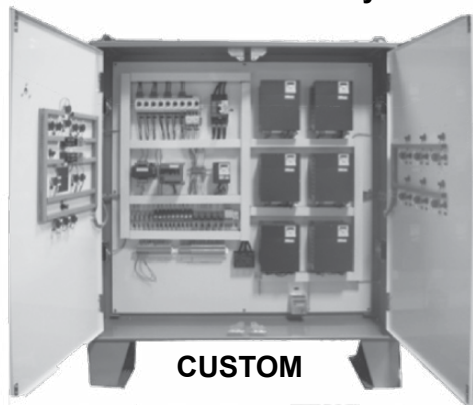

CUSTOM



DUPLEX



MAASS PROTECTIVE WELL ENCLOSURE



Features:

- For Maass JX1 and Model MB Pitless Units
- Welded air vent with stainless steel screen
- Stainless steel lock pins
- Shielded Locks
- Two lifting eyes on lid
- Detent pins for quick release of unit
- Specify base options: Cemented or Anchor bolt secured mounting base
- Catalytic epoxy coated
- Fits all sizes up to 26" well casing

PART NO.	SIZE	LIST PRICE
927630	24" X 30"	See separate price list
927635	30" X 30"	
927640	36" X 30"	
927645	42" X 32"	

PITLESS ADAPTER "O" RINGS

PROTECTIVE WELL ENCLOSURE
PITLESS "O" RING ADAPTERS



dicken™ SERIES		
PART NO.	SIZE	LIST PRICE
017304	JR-S10	See separate price list
017304	LDS-10	
017315	LDS-12	
017300	S-10	
017315	S-12	
017344	S-15	
017325	S-20	
017300	LD-2X UPPER/LDX2 LOWER	
018315	CW-4-10	
018315	CW-5-10	
018315	CW-6-10	
018315	CW-4-10WA	
018315	CW-4.5-10WA	
018315	CW-5-10WA	

MAASS J-JX-JC SERIES		
PART NO.	SIZE	LIST PRICE
001030	J1	See separate price list
001030	JC 1-1/4	
001032	J1-1/4	
001032	J1-1/2	
001034	J2	
001036	J2-1/2	
001038	J3	
001040	J4	
990000	Model J O-Ring Repair Kit	

NOTE: Model J O-Ring Repair Kit contains: 12 pcs. J1 O-Rings, 6 pcs. J11/4 / J11/2 O-Rings and 3 pcs. J2 O-Rings.

MAASS MODEL MB UNITS		
PART NO.	SIZE	LIST PRICE
001008	8" MB HD	See separate price list
001010	10" MB HD	
001012	12" MB HD	
001014	14" MB HD	
001016	16" MB HD	
001018	18" MB HD	
001020	20" MB HD	
001022	22" MB HD	
001024	24" MB HD	

NOTE: MB spool requires two "O" rings

VITON "O" RINGS		
PART NO.	SIZE	LIST PRICE
017350	LDS-10	See separate price list
017352	S-10	
017355	S-12	
017360	S-20	
001060	J1	
001062	J1-1/4	
001064	J2	
001066	J2-1/2	
001070	J-4	

MAASS SEWAGE ADAPTERS

MAASS SEWAGE ADAPTERS (JS)

Features:

- Allows for easy service to any submersible pump installation
- Brass and 304 stainless material with Viton o-ring seal used to combat corrosion
- Not necessary to pump tank to service pump
- Rail system can be fabricated by installer or Maass
- Large 8° taper slide for ease of installation or removal
- Can be used in cisterns and curb wells

Part Number	Model Number	NPT Size	Dimensions (Inches)				Weight (Lbs.)	List Price
			A	B	C	D		
928800	JS 1 1/4	1-1/4	4	6	5-1/8	2-1/8	4000	See separate price list
928805	JS 1 1/2	1-1/2	4-1/4	6	5-1/4	2-1/8	4000	
928810	JS 2	2	5-1/2	7	6-7/8	2-3/4	5000	
928815	JS 3	3	7-1/2	10	9-1/2	3-1/2	5000	
928820	JS 4	4	7-3/4	12	10-1/2	4-1/8	5000	

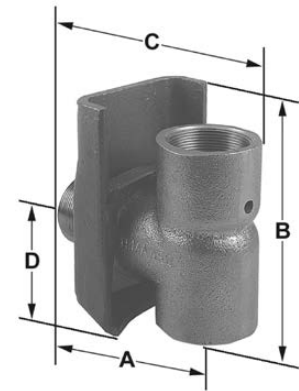

MAASS SEWAGE ADAPTER SLIDE RAIL SYSTEM

Feature:

- Rails used to hold adapter in position as well as providing guide system for brass insert
- Rails provided are welded in place on J.S. adapter

Part Number	For Models	Angle Size	List Price
928900	JS1 1/4, 1 1/2, 2	1/4 x 1 x 1	See separate price list
928905	JS3, 4	1/4 x 1-1/2 x 1-1/2	

NOTE: Please specify slide rail length when ordering



MAASS SEWAGE ADAPTERS (JSB)

Feature:

- Large 8° Taper Slide for ease of installation or removal
- 2" NPT inlet and outlet
- 1" pipe used for guides and support
- 100% brass construction with Viton o-ring seal for corrosion resistance
- Allows for easy service to any submersible pump installation
- Not necessary to pump tank to service pump

Part Number	Model Number	NPT size	List Price
928989	JSB-2	2	See separate price list

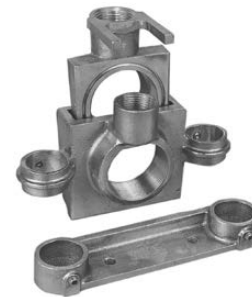

JSB-2 STAND OFF BRACKET

Feature:

- 304 SS construction
- Easily installed beneath septic tank lid or off the wall
- Utilizes (2) 1/2" bolts for pipe guide system (not provided)

Part Number	Model Number	NPT size	List Price
928985	JSB-2	2"	See separate price list



MAASS SEWAGE ADAPTERS

SEWAGE ADAPTER ACCESSORIES

JSB-2 UNIVERSAL STAND OFF BRACKET

Features:

- 19" overall length allows adjustment every 4 1/2 inches for 1" guide pipe
- Durable two part epoxy coating
- Utilizes (2) 1/2" bolts for installation to tank wall (not provided)



Part Number	For Model	Mounting Holes	List Price
928995	JSB-2	9/16"	See separate price list



dicken™ SUMP/SEWAGE ADAPTERS

Features:

- Precision machined all red brass castings
- Chamfered slide for fast and easy installation
- Red brass ell and slide with Viton o-ring seal

Part Number	Model	Discharge Pipe (Inches)	Supply Pipe (Inches)	Casing Size Nominal (Inches)	Hole Size, Required (Inches)	Shipping Weight (Lbs.-oz)	Working Load (Lbs.)	Qty./Carton	List Price Each
952178	LD-S-10-CO	1	1	5-12	1-3/4	4.0	2,000	10	See separate price list
952180	LD-S-12-CO	1-1/4	1-1/4	5-12	2-1/4	5.0	2,000	12	
952182	S 20-CO	2	2	5-5/8-12	3-1/8	14.0	5,000	4	

SEWAGE ADAPTER ACCESSORIES

ABS SUMP/SEWAGE CHECK VALVE

Features:

- Full flow design
- Two piece ABS body (sonic welded)
- Buna-N flapper seal provides positive sealing
- Valves provided with (4) stainless steel clamps
- DRS model provided with two rubber reducer sleeves



Part Number	Model No.	Description	List Price Each
940155	BSC-200-SB	2" IPS	See separate price list
940150	BSC-125/150 DRS	1-1/4 or 1-1/2 IPS	

PITLESS ADAPTER ACCESSORIES

TORCH CUTTING GUIDE:

For ease of installation of Model J or JC Pitless Adapter. Please specify casing O.D. and discharge size when ordering

Part Number	Model Number	List Price
928010	CG	See separate price list



CG



LD-S-10 PA



CW-5-10-WA-PA

PITLESS ACCESSORY OPTION AND PRESSURE SWITCH PACKAGE

Features:

- Allows pressure relief valve or pressure switch to be mounted in the well
- System drain valve may be located in the well; check local codes
- PA option is 1/2" tapping on back of 1" brass insert
- Use with pressure transducers

Part Number	Model Number	List Price
928000	5J1 PA	See separate price list
928002	6J1 PA	
928003	5JC1 PA	
928004	6JC1 PA	
953110	LD-5-10-PA	



5J1-PA

• **NOTE:** Used on 1" discharge adapters in 5" casing or larger.

- PSP package includes 1/4" x 9' coiled hose, 1/4" x 1/2" brass bushing, pulsation plug, and two stainless steel brackets for mounting pressure switch in the well

Part Number	Model Number	List Price
928005	PSP	See separate price list

NOTE: It is the customer's responsibility for ordering proper product to meet local, state and federal code regulations.



PSP

PITLESS ADAPTER
ACCESSORIES

Dicken™ ALUMINUM WELL CAPS

WTCC-Style CAST ALUMINUM

Features:

- WTCC caps Water Systems Council - PAS-2 listed
- Cast aluminum with stainless steel bolts
- WTCC models are vented to meet state codes
- Can be personalized, 50 piece minimum
- Five bolt pulldown for sure seal and tamper resistance
- Heavy Buna-N Seal prevents foreign matter intrusion
- Buna-N rubber seal is internal to cap assembly and is not exposed to outside environment



Part Number	Model	I.D. Casing Size (In.)	O.D. Casing Size (In.)	Conduit Fitting	Shipping Weight (Lbs.)	Qty./Carton	List Price Each
952800	WTCC-4	4	4-1/2	1" NPT	2.7	20	See separate price list
952802	WTCC-5	5	5-9/16	1" NPT	3.0	18	
952804	WTCC-5.6	5-5/8	6	1" NPT	3.2	15	
952806	WTCC-6	6	6-5/8	1" NPT	3.5	15	
952805	WTCC-6	6	6-5/8	1-1/4" NPT	3.5	15	
952812	WTCC-6	6	6-5/8	1-1/2" NPT	3.5	15	
952824	WTCC-6LC*	6	6-5/8	1" NPT	4.1	IND.	
952808	WTCC-6.6	6-5/8	7	1-1/4" NPT	3.7	10	
952810	WTCC-8	8	8-5/8	1-1/4" NPT	4.0	8	
952813	WTCC-8	8	8-5/8	1-1/2" NPT	5.0	8	

• NOTE: WTCC-6LC is locking.

AWT-Style



Part Number	Model	O.D. Casing Size (In.)	Conduit Fitting	Weight (Lbs.)	List Price Each
952848	10AWT	10-3/4	2 NPT	9.0	See separate price list
952849	12AWT	12-3/4	2 NPT	11.0	

WTCC - Style CHLORINE CAP

Features:

- Tapped 1 1/4" NPT to accommodate pellet chlorinators



Part Number	Model	I.D. Casing Size (In.)	O.D. Casing Size (In.)	Shipping Weight (Lbs.)	Qty./Carton	List Price Each
952814	WTCC 5 CL	5	5-9/16	3.0	18	See separate price list
952816	WTCC 6 CL	6	6-5/8	3.5	15	

WTCCI - Style CAST IRON

Features:

- WTCCI Caps Water Systems Council - PAS-97 (04) listed
- Cast iron with stainless steel bolts
- WTCCI models are vented to meet state codes
- Five bolt pulldown for sure seal and tamper resistance
- Heavy Buna-N Seal prevents foreign matter intrusion
- Buna-N rubber seal is internal to cap assembly and is not exposed to outside environment
- Equipped with an ultra flexible 6" grounding connector 12 AWG, UL486A and UL486C listed and tested to CSA standards



Part Number	Model	I.D. Casing Size (In.)	O.D. Casing Size (In.)	Conduit Fitting	Shipping Weight (Lbs.)	Qty./Carton	List Price Each
952902	WTCI-5	5	5-9/16	1" NPT	4.6	18	See separate price list
952906	WTCI-6	6	6-5/8	1" NPT	5.1	15	
952908	WTCI-6.6	6-5/8	7	1 1/4" NPT	5.2	10	
952910	WTCI-8	8	8-5/8	1 1/4" NPT	20.2	8	

DICKEN ALUMINUM WELL CAPS

MAASS™ THERMOPLASTIC/ABS WELL CAPS

SCP-Style

Features:

- SCP caps Water Systems Council PAS-2 listed
- Gasket to prevent foreign intrusion
- When cap top removed - wire completely exposed for easy service
- Stainless steel nuts and bolts
- Downward facing stainless steel vent
- ABS bottom, can be solvent welded to PVC casing



Part Number	Model	I.D. Casing Size (In.)	O.D. Casing Size (In.)	Conduit Fitting	Shipping Weight (Lbs.)	Qty./ Carton	List Price Each
952920	SCP4	4	4 1/2	1" NPT	.88	1	See separate price list
952925	SCP5	5	5 9/16	1" NPT	1.3	1	
952930	SCP6	6	6 5/8	1" NPT	1.5	1	

dicken™ ALUMINUM WELL CAPS

CC-Style

Features:

- Can be personalized, 50 piece minimum
- Cast aluminum alloy 319 - will not crack or warp
- Fitted for 1" conduit
- Three square head stainless steel cup point set screws
- Designed for 1/64" clearance fit to prevent foreign matter intrusion
- Model CC-ID cap 1-1/4" conduit as standard



Part Number	Model	I.D. Casing Size (In.)	O.D. Casing Size (In.)	Shipping Weight (Lbs.)	Qty./ Carton	List Price Each
952700	CC-4	4	4-1/2	1.2	36	See separate price list
952702	CC-4.5	4-1/2	5	1.3	29	
952704	CC-5	5	5-9/16	1.7	20	
952706	CC-56	5-5/8	6	1.75	21	
952708	CC-6	6	6-5/8	1.4	21	
952710	CC-66	6-5/8	7	2.0	18	
952712	CC-8	8	8-5/8	2.8	12	
952714	CC-10	10	10-3/4	4.1	8	

PC-Style

Features:

- Cast aluminum alloy 319 - will not crack or warp
- Square head zinc plated steel cup point set screw



Part Number	Model	I.D. Casing Size (In.)	O.D. Casing Size (In.)	Shipping Weight (Lbs.)	Qty./ Carton	List Price Each
952600	PC-4	4	4-1/2	.7	36	See separate price list
952602	PC-5	5	5-9/16	1.75	22	
952604	PC-566 (2-step)	5-5/8 upper 6 lower	6 6-5/8	1.8	21	
952606	PC-66	6-5/8	7	2.2	21	
952608	PC-8	8	8-5/8	2.8	12	
952610	PC-10	10	10-3/4	3.5	8	
952612	PC-12	12	12-3/4	5.3	4	

MAASS™ SUBMERSIBLE WELL CAPS

Features:

- Heavy duty cast aluminum - will not crack or warp
- Stainless steel set screws

Part Number	Model	O.D. Casing Size (In.)	Weight (Lbs.)	List Price Each
952748	10S	10-3/4	5.75	See separate price list
952750	12S	12-3/4	8.6	



• NOTE: Locking well caps illustrated on page 73.

MAASS/DICKENS ALUMINUM & PLASTIC WELL CAPS

WELL SECURE



Features:

- Provides visible proof of the integrity of the well
- Protect your company from unwarranted customer claims
- Can be custom printed with your company name, logo, phone number
- Insure the integrity of monitoring wells between sampling
- Easily applied by heat source

Monitoring and Test Well Size Chart

Part Number	Fits Well Cap Sizes	Color	Cap Circumference	List Price
952952	2 Inch MW	Red	9"	See separate price list
952954	4 inch MW	Red	14-3/4"	



Maass Midwest Well Cap Size Chart

Part Number	Fits Well Cap Sizes	Color	Cap Circumference	List Price
952961	PC-4	Green	16-17"	See separate price list
952962	CC-4, CC-4.5	Green	19-21"	
952963	WTCC-4, CC-5, PC-566	Green	22-24"	
952964	WTCC-5, CC-6, PC-66	Green	24-26"	
952965	WTCC-5.6, CC-6.6	Green	26-27"	
952966	WTCC-6, PC-8	Green	29-30"	
952967	WTCC-6.6	Green	30-31"	
952968	CC-8	Green	31-32"	
952969	WTCC-8	Green	36-37"	



Well Secure Heat Gun

Features:

- Instant push button start
- Variable head adjustment
- Attaches to standard 14 oz. propane tank (not included)

Part Number	List Price
952951	Well Secure Heat Gun See separate price list

POND/IRRIGATION FILTERS



Features:

- Effective means of keeping algae and seaweed out of pumping system
- Manufactured from heavy PVC and plastic
- 2" suction connectors
- Outside screen used 1/4" holes
- 2" PVC check valves as standard
- Area between screens filled with bulk fish-safe filter mating
- Can be manifolded to increase capacity
- Irregular 3/8" or larger pea gravel can also be used as filter media

Part Number	Model	GPM	Screen O.D.	Inner Screen	Weight Ea. (Lbs.)	List Price
940185	40 G	40 Gal.	12"	6"	7	See separate price list
940186	80 G	80 Gal.	6"	2"	17	

Note: Filter stands are also available



WELL SECURE
POND/IRRIGATION FILTERS

STRAINERS

STEEL SUCTION STRAINER

Features:

- General purpose strainer
- Strainer holes are 3/8"

Part Number	Size (Inches)	Height (Inches)	O.D. (Inches)	Weight (Lbs.)	List Price
940168	1-1/2	3-1/2	5	1.5	See separate price list
940171	2	4	6	2.0	
940174	2-1/2	4	6	2.0	
940177	3	5	7	3.0	
940180	4	5	7	3.0	
940183	6	9	9	11.0	



542

SUBMERSIBLE PUMP STRAINER

Features:

- Protect submersible pump from costly sand damage
- Bottom cap manufactured from FDA approved plastic
- Stainless steel standard
- Seams are spot-welded

Part Number	Size (in. X ft.)	Gauze	Weight (Lbs.)	List Price
915620	3 x 2	80	1.4	See separate price list
915622	3 x 2	100	1.4	
915630	3 x 4	80	2.3	
915632	3 x 4	100	2.3	
915641	4 x 4	80	3.2	
915642	4 x 4	100	3.2	
915638	4 x 6	80	5.2	
915639	4 x 6	100	5.2	

- Please specify pump manufacture when ordering 3" pump strainers
- 3" size fits 4" I.D. casing
- 4" size fits 4 1/2" I.D. or larger casing



1536-S

FEMALE SUCTION PIPE STRAINER

Features:

- Wire wound stainless steel strainer

Part Number	Model	Slot Size	Pipe Size	Weight (Lbs.)	List Price
92320	1024	10	2	2.1	See separate price list



FLOWSLEEVE

Features:

- An efficient pump cooling system at an economical cost
- Quick and easy installation
- Recommended for longer life
- Directs flow over motor, properly cooling motor
- Easy to assemble using standard schedule 40 PVC pipe
- Excellent for storage tanks, ponds, cisterns and water well aeration systems

Part Number	Description	List Price
962500	4" Flowsleeve - 1" Discharge	See separate price list
962510	4" Flowsleeve - 1-1/4" Discharge	
962520	4" Flowsleeve - 1-1/2" Discharge	
962530	4" Flowsleeve - 2" Discharge	
962550	Pond and Lake Pump Mounting Stand - keeps pump off lake bottom	



STRAINERS/FLOWSLEEVE



MODEL JXX - PITLESS BURY UNITS

Features:

- Designed to accommodate two pumps in one well casing
- Excellent for geothermal closed systems
- Can be used for one pump and one return pipe well
- Available with male threaded end or plain end for welding
- Standard 18" minimum overall length

Part Number	Model Number	Well Casing Size	Water Outlet & Drop Pipe Size	List Price Each
926415	5JXX-1	5	1	See separate price list
926435	6JXX-1	6	1	
926440	6JXX-1 1/4	6	1-1/4	
926460	8JXX-1	8	1	
926475	8JXX-2	8	2	
926485	10JXX-2	10	2	

SURE CLIP LLC GEOTHERMAL PIPE SPACERS

Features:

- Increases vertical bore heat exchange by 35%
- Anti-catch design allows the tremie to be extracted without a snag
- Patent pending
- Made in the USA



"DOG BONE" SPACER

Part Number	Model Number	Pipe Size SDR11	Minimum Bore Diameter	List Price Each
933300	GSC-75-2	3/4"	5.50"	See separate price list
933302	GSC-100-2	1"	5.50"	
933304	GSC-125-2	1-1/4"	6.00"	



"QUAD BONE" SPACER

Part Number	Model Number	Pipe Size SDR11	Minimum Bore Diameter	List Price Each
933306	GSC-75-4	3/4"	5.50"	See separate price list
933308	GSC-100-4	1"	6.00"	



GEOTHERMAL BRASS ELBOW

Features

- 1" X 1" Elbow
- One port male X sweat combination
- Tapped 1/4" for heat pump sensor

Part Number	IPS X IPS	Quantity per Carton	Weight per Carton	List Price Each
406502	1" X 1"	10	7.5	See separate price list

SEDIMENT FILTERS

SPINDOWN™ MODEL

Features:

- PVC body
- Ball valve for flushing sand and sediment
- Polyester filter screen is reusable
- Sand and sediment is visible through clear reservoir
- Maximum operating pressure 150 psi at 73O F
- Individually boxed



SEDIMENT FILTERS
REPAIR PARTS

Part Number	Model Number	Pipe Size	Mesh	Length	Width	List Price Each
962002	3/4-24F	3/4"	24	11-3/8	7-1/4"	
962004	3/4-30F	3/4"	30	11-3/8	7-1/4"	
962006	3/4-40F	3/4"	40	11-3/8	7-1/4"	
962008	3/4-60F	3/4"	60	11-3/8	7-1/4"	
962010	3/4-100F	3/4"	100	11-3/8	7-1/4"	
962012	3/4-140F	3/4"	140	11-3/8	7-1/4"	
962014	3/4-250F	3/4"	250	11-3/8	7-1/4"	
962020	1-24F	1" slip	24	11-3/8	5"	
962022	1-30F	1" slip	30	11-3/8	5"	
962024	1-40F	1" slip	40	11-3/8	5"	
962026	1-60F	1" slip	60	11-3/8	5"	
962028	1-100F	1" slip	100	11-3/8	5"	
962030	1-140F	1" slip	140	11-3/8	5"	
962032	1-250F	1" slip	250	11-3/8	5"	
962038	1-1/2-24F	1-1/2" slip	24	15	5-1/4"	See separate price list
962040	1-1/2-30F	1-1/2" slip	30	15	5-1/4"	
962042	1-1/2-40F	1-1/2" slip	40	15	5-1/4"	
962044	1-1/2-60F	1-1/2" slip	60	15	5-1/4"	
962046	1-1/2-100F	1-1/2" slip	100	15	5-1/4"	
962048	1-1/2-140F	1-1/2" slip	140	15	5-1/4"	
962050	1-1/2-250F	1-1/2" slip	250	15	5-1/4"	
962056	2-24F	2" slip	24	18	5-3/4"	
962058	2-30F	2" slip	30	18	5-3/4"	
962060	2-40F	2" slip	40	18	5-3/4"	
962062	2-60F	2" slip	60	18	5-3/4"	
962064	2-100F	2" slip	100	18	5-3/4"	
962066	2-140F	2" slip	140	18	5-3/4"	
962068	2-250F	2" slip	250	18	5-3/4"	

REPAIR PARTS

POLYESTER FILTER ELEMENTS

SPINDOWN™ MODEL

Part Number	Model Number	Size (Inches)	List Price Each
962300	NT30SC24	3/4 and 1	See separate price list
962302	NT30SC30	3/4 and 1	
962306	NT30SC60	3/4 and 1	
962308	NT30SC100	3/4 and 1	
962310	NT30SC140	3/4 and 1	
962312	NT30SC250	3/4 and 1	
962318	NT60SC24	1-1/2	
962320	NT60SC30	1-1/2	
962324	NT60SC60	1-1/2	
962326	NT60SC100	1-1/2	
962328	NT60SC140	1-1/2	
962330	NT60SC250	1-1/2	
962336	NT120SC24	2	
962338	NT120SC30	2	
962342	NT120SC60	2	
962344	NT120SC100	2	
962346	NT120SC140	2	
962348	NT120SC250	2	

- Repair parts replace Rusco™ filters parts

SEDIMENT FILTERS

SPINDOWN™ SEDIMENT TRAPPER MODEL

Features:

- Centrifuge spin down action removes sand and coarse sediment
- Several mesh sizes available
- Polyester filter screens are replaceable
- Sediment is easily removed by opening ball valve at bottom of filter
- Hand tighten only – use of tools voids warranty
- Sand and sediment is visible through clear reservoir



SEDIMENT FILTERS
REPAIR PARTS

Part Number	Model Number	Pipe Size	Mesh	Length	Width	List Price Each
962100	3/4-24STF	3/4"	24	14-1/2	7-1/4"	See separate price list
962102	3/4-30STF	3/4"	30	14-1/2	7-1/4"	
962104	3/4-40STF	3/4"	40	14-1/2	7-1/4"	
962106	3/4-60STF	3/4"	60	14-1/2	7-1/4"	
962108	3/4-100STF	3/4"	100	14-1/2	7-1/4"	
962110	3/4-140STF	3/4"	140	14-1/2	7-1/4"	
962112	3/4-250STF	3/4"	250	14-1/2	7-1/4"	
962118	1-24STF	1" slip	24	14-1/2	5"	
962120	1-30STF	1" slip	30	14-1/2	5"	
962122	1-40STF	1" slip	40	14-1/2	5"	
962124	1-60STF	1" slip	60	14-1/2	5"	
962126	1-100STF	1" slip	100	14-1/2	5"	
962128	1-140STF	1" slip	140	14-1/2	5"	
962130	1-250STF	1" slip	250	14-1/2	5"	
962140	1-1/2-24STF	1-1/2" slip	24	15	5-1/4"	
962142	1-1/2-30STF	1-1/2" slip	30	15	5-1/4"	
962144	1-1/2-40STF	1-1/2" slip	40	15	5-1/4"	
962146	1-1/2-60STF	1-1/2" slip	60	15	5-1/4"	
962148	1-1/2-100STF	1-1/2" slip	100	15	5-1/4"	
962150	1-1/2-140STF	1-1/2" slip	140	15	5-1/4"	
962152	1-1/2-250STF	1-1/2" slip	250	15	5-1/4"	
962160	2-24STF	2" slip	24	18	5-3/4"	
962162	2-30STF	2" slip	30	18	5-3/4"	
962164	2-40STF	2" slip	40	18	5-3/4"	
962166	2-60STF	2" slip	60	18	5-3/4"	
962168	2-100STF	2" slip	100	18	5-3/4"	
962170	2-140STF	2" slip	140	18	5-3/4"	
962172	2-250STF	2" slip	250	18	5-3/4"	

REPAIR PARTS

POLYESTER FILTER ELEMENTS

SEDIMENT TRAPPER MODEL

Part Number	Model Number	Size (Inches)	List Price Each
962360	NT1SC24	3/4 and 1	See separate price list
962362	NT1SC30	3/4 and 1	
962366	NT1SC60	3/4 and 1	
962368	NT1SC100	3/4 and 1	
962370	NT1SC140	3/4 and 1	
962372	NT1SC250	3/4 and 1	
962378	NT1.5SC24	1-1/2	
962380	NT1.5SC30	1-1/2	
962382	NT1.5SC60	1-1/2	
962384	NT1.5SC100	1-1/2	
962386	NT1.5SC140	1-1/2	
962390	NT1.5SC250	1-1/2	
962400	NT2SC24	2	
962402	NT2SC30	2	
962406	NT2SC60	2	
962408	NT2SC100	2	
962410	NT2SC140	2	
962412	NT2SC250	2	

- Repair parts replace Rusco™ filters parts

REPAIR PARTS

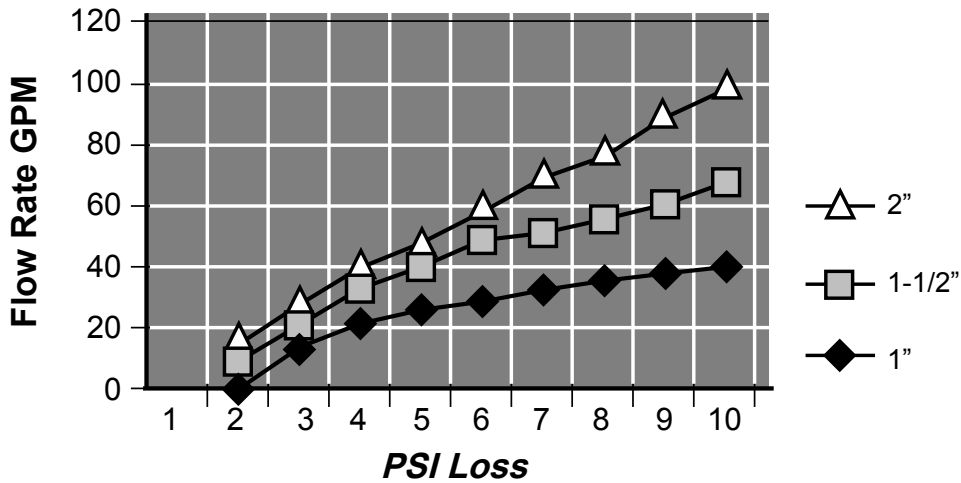

Inlet/Outlet	Flow Rate 1"
1"	1 - 25 Gpm
1 1/2"	10 - 50 Gpm
2"	20 - 100 Gpm

Part Number	Model Number	Description	Size (Inches)	List Price Each
962250	PV	Purge Valve	1/2 FPT	See separate price list
962252	NT30B	Filter Body	1"	
962254	NT60B	Filter Body	1-1/2"	
962256	NT120B	Filter Body	2"	
962258	NT30C	Filter Cover - Spindown™ Model	3/4" TO 1"	
962276	NT60C	Filter Cover - Spindown™ Model	1-1/2"	
962278	NT120C	Filter Cover - Spindown™ Model	2"	
962270	NT1C	Filter Cover - Trapper Model	1"	
962260	NT30S	"O" Ring Trapper & Spindown™	1"	
962262	NT60S	"O" Ring Trapper & Spindown™	1-1/2"	
962280	NT120S	"O" Ring Trapper & Spindown™	2"	

MESH CONVERSION CHART

Mesh	Opening	Microns
24	.028	711
30	.021	533
40	.015	381
60	.010	254
100	.006	152
140	.004	104

REPAIR PARTS
TRI-SEAL/K-PACKER

SANDBLOCKER™ II WELL SCREENS

Patent No. 5,833,853 | New Innovation in Sand Retention

TRANSMITTING CAPACITY Gallons per Minute per Foot of Screen at 0.1 foot per second	
Screen Pipe Size (Inches)	GPM/FT
2	8
3	12
4	16
5	21
6	25

- Features:
- Large inflow area of 32%, providing twice the flow of wire wrap screens
- Rugged design, strongest stainless steel screen in market today
- One size fits all, from comparable slot size of 3 and larger
- Resistant to plugging and erosion, pore size distribution replicates sand size distribution
- Gravel pack not required
- Stainless steel construction throughout

STAINLESS STEEL DRIVE POINTS | MALE X POINT

Part Number	Size	Screen O.D.	Screen Length	List Price Each
916802-3	2"	2.50	36"	See separate price list
916802-4	2"	2.50	48"	

SANDBLOCKER™ II WELL SCREENS

STAINLESS STEEL EXTENSIONS

Part Number	Size	PIPE SIZE 2" NPT MALE X FEMALE		List Price Each
		Screen O.D.	Screen Length	
916812-4	2"	2.50	48"	See separate price list

Note: Male x Male, Female x Female and ASTM Flush Fitting available.

WELL SCREENS

Part Number	Size	PIPE SIZE 2" NPT MALE X FEMALE		List Price Each
		Screen O.D.	Screen Length	
916813-3	3"	3.50	3'	See separate price list
916813-5	3"	3.50	5'	
PIPE SIZE 3" NPT FEMALE X FEMALE				
916853-3	3"	3.50	3'	See separate price list
916853-5	3"	3.50	5'	
PIPE SIZE 3" NPT FEMALE X PLATE BOTTOM				
916833-3	3"	3.50	3'	See separate price list
PIPE SIZE 4" NPT FEMALE X FEMALE				
916854-4	4"	4.50	4'	See separate price list
PIPE SIZE 4" NPT MALE X FEMALE				
916814-4	4"	4.50	4'	See separate price list
PIPE SIZE 4" NPT MALE X PLATE BOTTOM				
916834-2	4"	4.50	2'	See separate price list
916834-4	4"	4.50	4'	
PIPE SIZE 5" NPT MALE X PLATE BOTTOM				
916835-3	5"	5.50	3'	See separate price list
PIPE SIZE 5" WELD RING X WELD RING				
916885-3	5"	5.50	3'	See separate price list
916885-6	5"	5.50	6'	
PIPE SIZE 6" NPT MALE X PLATE BOTTOM				
916836-5	6"	6.50	5'	See separate price list
PIPE SIZE 6" WELD RING X WELD RING				
916886-5	6"	6.50	5'	See separate price list

Note:

- Longer screen lengths available by splicing various standard lengths together.
- Other sizes available. Contact factory for price and availability.

SANDBLOCKER WELL SCREENS



DRIVE WELL POINTS



MIDWEST WELD PROCESS WELL POINT

Features:

- Rugged design with octagonal ductile iron head to prohibit turning in tough driving
- Easily extended in the field by removing head and coupling together with second well point for added capacity
- Bronze MIG weld top and bottom to prohibit jacket shift or peeling
- 3/16" diameter spotweld on 1" centers to prevent seam opening
- Stainless steel with 1/8" staggered perforations for maximum open area
- Available in 50-60-80-100 mesh stainless steel for long life screening
- Other custom lengths and styles available
- Lead Free: ≤ .025% Lead Content

STAINLESS STEEL

Part Number	Model Number	Gauze	Pipe Size	Pipe Lg. X Jacket	Weight (Lbs.)	List Price Each
915698	SS90	60	1-1/4	24 x 18	6	See separate price list
915702	SS90	80	1-1/4	24 x 18	6	
915716	SS94	60	1-1/4	30 x 24	7	
915720	SS94	80	1-1/4	30 x 24	7	
915734	SS98	60	1-1/4	36 x 30	8	
915738	SS98	80	1-1/4	36 x 30	8	
915752	SS100	60	1-1/4	42 x 36	10	
915756	SS100	80	1-1/4	42 x 36	10	
915770	SS102	60	1-1/4	48 x 42	11	
915774	SS102	80	1-1/4	48 x 42	11	
915788	SS110	60	1-1/4	60 x 54	13	
915792	SS110	80	1-1/4	60 x 54	13	
915834	SS164	60	2	30 x 24	12	
915838	SS164	80	2	30 x 24	12	
915852	SS168	60	2	36 x 30	14	
915856	SS168	80	2	36 x 30	14	
915870	SS172	60	2	48 x 42	18	
915874	SS172	80	2	48 x 42	18	
915888	SS176	60	2	60 x 54	22	
915892	SS176	80	2	60 x 54	22	

OPEN END WELL SCREEN

Features:

- Use when jetting or washing down wells using a sand shark or backwash valve
- Provides additional capacity when coupled with a well point

Part Number	Model Number	Gauze	Pipe Size	Pipe Lg. X Jacket	Weight (Lbs.)	List Price Each
916345	SS99	60	1-1/4	36 x 30	7	See separate price list
916348	SS103	60	1-1/4	48 x 42	10	
916400	SS169	60	2	36 x 30	11	
916404	SS173	60	2	48 x 42	15	
916406	SS177	60	2	60 x 54	17.8	

FLUSH WELL POINTS

Features:

- 1-1/4" flush point fits in 2" well and will pass through 2" closed pattern drive shoe
- SS - Stainless steel
- Used in tubular drilled wells

Part Number	Trade Number	Gauze	Pipe Size	Pipe Lg. X Jacket	Weight (Lbs.)	List Price Each
916064	SS121	60	1-1/4	36 x 30	9	See separate price list
916068	SS121	80	1-1/4	36 x 30	9	
916088	SS125	60	1-1/4	42 x 36	10	
916092	SS125	80	1-1/4	42 x 36	10	
916142	SS129	60	1-1/4	48 x 42	11	
916146	SS129	80	1-1/4	48 x 42	11	
916160	SS131.5	60	1-1/4	54 x 48	13	
916164	SS131.5	80	1-1/4	54 x 48	13	
916196	SS570	60	1-1/4	60 x 54	14	
916200	SS570	80	1-1/4	60 x 54	14	

DRIVE WELL POINTS
FLUSH WELL POINTS



WASHER WELL POINTS



Features:

- For use in ground with sharp stones or rocks
- Drilled and countersunk holes are covered with wire cloth and held in place by washers.

Part Number	Trade Number	Gauze	Pipe Size	Pipe Lg. X Jacket	Weight (Lbs.)	List Price Each
916460	SS301	60	1-1/4	24	6	See separate price list
916462	SS301	80	1-1/4	24	6	
916482	SS302	60	1-1/4	30	7	
916486	SS302	80	1-1/4	30	7	
916500	SS303	60	1-1/4	36	8	
916504	SS303	80	1-1/4	36	8	
916518	SS305	60	1-1/4	48	11	
916522	SS305	80	1-1/4	48	11	
916594	SS325	60	2	36	13	
916598	SS325	80	2	36	13	
916612	SS327	60	2	48	16	
916616	SS327	80	2	48	16	

STAINLESS STEEL MONITOR POINT

Features:

- Stainless steel tubing and point can be fabricated to provide an excellent aid for monitoring
- Minimum quantity of twelve units required
- Refer to page 73 for monitoring points

WELL POINT ACCESSORIES

USA MADE DRIVE COUPLINGS GALVANIZED

Part Number	Pipe Size (Inches)	Approx. Weight (Lbs.)	Quantity Per Box	List Price Each
941574	1-1/4	1.0	25	See separate price list
941576	2	1.5	15	



9

DRIVE CAPS MALLEABLE

Part Number	Pipe Size (Inches)	Approx. Weight (Lbs.)	Quantity Per Box	List Price Each
930562	1-1/4	1.5	25	See separate price list
930568	2	3.25	10	



618

“SAND SHARK” BACKWASH VALVES

Features:

- Cast iron housing

Part Number	Valve Size (Inches)	Pressure Pipe Tap (Inches)	Threads	Approx. Weight (Lbs.)	List Price Each
930141	2 NPT Male	1 NPS	Left Hand	2.0	See separate price list



810

BACKWASH VALVES

Features:

- No lead brass: ≤ .025% Lead Content
- Stainless steel spring and ballcheck

Part Number	Pipe Size (Inches)	Approx. Weight (Lbs.)	List Price Each
922804	1-1/4	.60	See separate price list
922810	2	.75	



800

WASHER WELL POINTS
WELL POINT ACCESSORIES

WELL SEAL ACCESSORIES



COPPER WELL SEAL AIR VENT

Features:

- Vermin proof
- Fabricated from copper
- Low profile

Part Number	Diameter	Length	Thread Size	List Price
930632	7/8"	2"	1/2" NPT	See separate price list
930634	1-1/4"	2-9/32"	3/4" NPT	

Note: 3/4" can be used on 8" or larger well seal



PVC WELL SEAL AIR VENT

Features:

- Fits most solid or split top well seals
- Slotted area provides vermin proof protection
- Manufactured from rugged PVC

Part Number	Diameter	Length	Thread Size	List Price
930630	1	5-1/2"	1/2" NPT	See separate price list



STEEL WELL SEAL AIR VENT

Features:

- Fabricated from 1/2" heavy duty galvanized steel
- Brass and stainless steel 24 mesh screen

Part Number	O.A. Length	Vent Height	Thread Size	Weight	List Price
934634	13"	8"	1/2" NPT	1.35	See separate price list
934636	17"	12"	1/2" NPT	1.10	



WELL SEAL ACCESSORIES
WELL SEALS

WELL SEALS

SINGLE PIPE WELL SEALS - SPLIT TOP

Features:

- Split cast iron top for ease of installation
- Cable seal kit included
- 6" seal and above has 1" cable hole
- Vent opening 1/2" NPT
- 4" and 5" seals have 3/4" cable hole

Part Number	Model Number	Size Casing I.D. X Drop Pipe	Hole Location	Weight (Lbs.)	List Price Each
930647	459S	4 x 1	Offset	3.9	See separate price list
930650	459S	4 x 1-1/4	Offset	3.2	
930656	459S	4 x 2	Offset	2.7	
930713	459S	5 x 1	Center	6.4	
930716	459S	5 x 1-1/4	Center	5.7	
930720	459S	5 x 2	Center	4.9	
930755	459S	5-5/8 x 1	Center	8.1	
930757	459S	5-5/8 x 1-1/4	Center	6.9	
930782	459S	6 x 1	Center	9.9	
930785	459S	6 x 1-1/4	Center	9.7	
930789	459S	6 x 2	Center	7.7	
930809	459S	6 -1/4 x 1	Center	7.5	
930811	459S	6-1/4 x 1-1/4	Center	8.1	
930815	459S	6-1/4 x 2	Center	7.8	
930850	459S	8 x 1	Center	17.3	
930852	459S	8 x 1-1/4	Center	17.4	
930856	459S	8 x 2	Center	16.1	
930858	459S	8 x 3	Center	14.1	
930860	459S	8 x 4	Center	11.7	



459S



SINGLE PIPE WELL SEALS - SOLID TOP

Features:

- One piece cast iron top meets Wisconsin State Code
- Cable seal kit included
- Vent opening 1/2" NPT
- 6" seal has 1" cable hole



459W

Part Number	Model Number	Size Casing I.D. I.D. X Drop Pipe	Hole Location	Weight (Lbs.)	List Price Each
930640	459W	4 x Blank	Blank	4.0	See separate price list
930654	459W	4 x 1	Center	3.9	
931259	459W	4 x 1	Offset	3.8	
931269	459W	5 x 1	Center	6.5	
931651	459W	6 x 0	None	8.7	
931275	459W	6 x 1	Center	8.6	
931278	459W	6 x 1-1/4	Center	8.5	
931282	459W	6 x 2	Center	7.5	



359

SINGLE PIPE WELL SEALS

Features:

- One piece cast iron top
- Provided with optional pointed set screws for threaded pipe

Part Number	Model Number	Size Casing I.D. I.D. X Drop Pipe	Hole Location	Weight (Lbs.)	List Price Each
931297	359	2 x 1	Center	2.5	See separate price list
931300	359	2 x 1-1/4	Center	2.3	

DOUBLE PIPE WELL SEALS - SPLIT TOP

Features:

- Two piece cast iron top



Part Number	Model Number	Size Casing I.D. I.D. X Drop Pipe	Weight (Lbs.)	List Price Each
950004	559	4 x 1-1/4 x 1	3.0	See separate price list
950006	559	4 x 1-1/4 x 1-1/4	3.0	
950015	559	5 x 1-1/4 x 1	5.0	
950031	559	6 x 1-1/4 x 1	9.0	
950033	559	6 x 1-1/4 x 1-1/4	9.0	

WELL SEALS



PACIFIC HYDRO™ STEEL SANITARY WELL SEALS

Features:

- Made from high strength steel
- Steel plates powder coated for durable finish
- Utilizes soft poly-vinyl packers
- Unique packer design allows for wide range of casing sizes
- Bolts and washers zinc plated
- 1" threaded wire drop hole standard on most well seals
- 1-1/4" threaded wire drop holes standard on 10" and larger seals
- Vent opening 1/2" on 4" to 7" well seals
- Vent opening 3/4" on 8" well seals and larger



Part Number	Model Number	Size Casing I.D. X Drop Pipe	Top Plate Thickness	Working Load (Lbs.)	Weight (Lbs.)	List Price Each
954010	WS41	4" to 4 -1/4" x 1"	3/16"	2,141	1.80	See separate price list
954011	WS41.25	4" to 4-1/4" x 1-1/4"	3/16"	2,141	1.76	
954012	WS41.5	4" to 4-1/4" x 1-1/2"	3/16"	2,141	1.65	
954013	WS42	4" to 4-1/4" x 2"	3/16"	2,141	1.55	
954004	WS5OD1	4-1/2" to 4-3/4" x 1"	3/16"	1,520	2.65	
954005	WS5OD1.25	4-1/2" to 4-3/4" x 1-1/4"	3/16"	1,520	2.35	
954006	WS6OD1	5-3/16" to 5-7/16" x 1"	3/16"	1,520	2.90	
954007	WS6OD1.25	5-3/16" to 5-7/16" x 1-1/4"	3/16"	1,520	2.90	
954015	WS51	5" to 5-1/4" x 1"	3/16"	1,450	2.70	
954016	WS51.25	5" to 5-1/4" x 1-1/4"	3/16"	1,450	2.40	
954017	WS51.5	5" to 5-1/4" x 1-1/2"	3/16"	1,450	2.55	
954018	WS52	5" to 5-1/4" x 2"	3/16"	1,450	2.85	
954020	WS61	5-3/4" to 6-1/4" x 1"	3/16"	1,100	3.60	
954021	WS61.25	5-3/4" to 6-1/4" x 1-1/4"	3/16"	1,100	3.60	
954022	WS61.5	5-3/4" to 6-1/4" x 1-1/2"	3/16"	1,100	3.35	
954023	WS62	5-3/4" to 6-1/4" x 2"	3/16"	1,100	3.35	
954024	WS62.5	5-3/4" to 6-1/4" x 2-1/2"	3/8"	9,170	4.70	
954025	WS63	5-3/4" to 6-1/4" x 3"	3/8"	9,170	5.00	
954026	WS6 1/4 x 1	5-3/4" to 6-1/4" x 1"	3/16"	1,150	3.60	
954027	WS6 1/4 x 1.25	5 -1/4" to 6-1/4" x 1-1/4"	3/16"	1,150	3.60	
954029	WS6 1/4 x 2	5-3/4" to 6-1/4" x 2"	3/16"	1,150	3.35	
954030	WS71	6-5/8" to 7-1/4" x 1"	1/4"	2,000	5.45	
954031	WS71.25	6-5/8" to 7-1/4" x 1-1/4"	1/4"	2,000	5.65	
954032	WS71.5	6-5/8" to 7-1/4" x 1-1/2"	1/4"	2,000	5.40	
954033	WS72	6-5/8" to 7-1/4" x 2"	1/4"	2,000	5.30	
954036	WS81	7-3/4" to 8-1/4" x 1"	1/4"	1,650	7.45	
954037	WS81.25	7-3/4" to 8-1/4" x 1-1/4"	1/4"	1,650	7.30	
954038	WS81.5	7-3/4" to 8-1/4" x 1-1/2"	1/4"	1,650	6.75	
954039	WS82	7-3/4" to 8-1/4" x 2"	1/4"	1,650	6.90	
954040	WS8.25	7-3/4" to 8-1/4" x 2-1/2"	3/8"	6,900	8.35	
954041	WS83	7-3/4" to 8-1/4" x 3"	1/2"	9,000	7.50	
954042	WS84	7-3/4" to 8-1/4" x 4"	5/8"	22,500	9.60	
954045	WS101	9-3/4" to 10-1/4" x 1"	3/8"	3,700	11.75	
954046	WS101.25	9-3/4" to 10-1/4" x 1-1/4"	3/8"	3,700	11.95	
954047	WS101.5	9-3/4" to 10-1/4" x 1-1/2"	3/8"	3,700	15.05	
954048	WS102	9-3/4" to 10-1/4" x 2"	3/8"	3,700	14.70	
954049	WS102.5	9-3/4" to 10-1/4" x 2-1/2"	1/2"	8,600	17.15	
954050	WS103	9-3/4" to 10-1/4" x 3"	5/8"	16,200	19.55	
954051	WS104	9-3/4" to 10-1/4" x 4"	5/8"	16,200	17.65	
954052	WS105	9-3/4" to 10-1/4" x 5"	3/4"	30,000	17.50	
954053	WS106	9-3/4" to 10-1/4" x 6"	3/4"	30,000	15.10	
954054	WS121	11-3/4" to 12-1/4" x 1"	1/4"	885	26.00	
954055	WS121.25	11-3/4" to 12-1/4" x 1-1/4"	3/8"	2,870	26.00	
954056	WS121.5	11-3/4" to 12-1/4" x 1-1/2"	3/8"	2,870	26.00	
954057	WS122	11-3/4" to 12-1/4" x 2"	1/2"	6,600	26.00	
954058	WS122.5	11-3/4" to 12-1/4" x 2-1/2"	1/2"	6,600	26.00	
954059	WS123	11-3/4" to 12-1/4" x 3"	5/8"	12,000	26.00	
954060	WS124	11-3/4" to 12-1/4" x 4"	5/8"	12,000	26.00	
954061	WS125	11-3/4" to 12-1/4" x 5"	3/4"	20,500	26.00	
954062	WS126	11-3/4" to 12-1/4" x 6"	3/4"	21,000	26.00	
954070	WS141.25	13 1/4" to 14" x 1 1/4"	3/8"	2,280	40	
954071	WS141.5	13 1/4" to 14" x 1 1/2"	1/2"	4,850	49	
954072	WS142	13 1/4" to 14" x 2"	1/2"	4,850	48	
954073	WS142.5	13 1/4" to 14" x 2 1/2"	1/2"	4,850	47	
954074	WS143	13 1/4" to 14" x 3"	5/8"	9,450	54	
954075	WS144	13 1/4" to 14" x 4"	3/4"	16,000	59	
954076	WS145	13 1/4" to 14" x 5"	3/4"	16,000	67	
954077	WS146	13 1/4" to 14" x 6"	1"	38,000	67	
954080	WS164	15 1/4" to 16" x 4"	3/4"	12,500	80	
954081	WS166	15 1/4" to 16" x 6"	1"	30,000	91	

• **NOTE:**

- Custom sizes available. Contact factory for quotation.
- Also available manufactured from stainless steel.

WELL SEALS



SUPER WELL SEALS

• 3/8" Thick Steel Top Plate

Part Number	Model Number	Size Casing I.D. X Drop Pipe	Top Plate Thickness	Working Load (Lbs.)	Weight (Lbs.)	List Price Each
954311	WS51.25	5" to 5-1/4" x 1-1/4"	3/8"	9,170	3.35	See separate price list
954312	WS51.5	5" to 5-1/4" x 1-1/2"	3/8"	9,170	3.35	
954313	WS52	5" to 5-1/4" x 2"	3/8"	9,170	3.35	
954320	WS61 X 3/8"	5-3/4" to 6-1/4" x 1"	3/8"	9,100	4	
954321	WS61.25 X 3/8"	5-3/4" to 6-1/4" x 1-1/4"	3/8"	9,100	4	
954322	WS61.5 X 3/8"	5-3/4" to 6-1/4" x 1-1/2"	3/8"	9,100	4	
954323	WS62 X 3/8"	5-3/4" to 6-1/4" x 2"	3/8"	9,100	4	
954326	WS6.4.1 X 3/8"	6-1/4" to 6-1/2" x 1"	3/8"	9,000	4	
954327	WS6.4.125 X 3/8"	6-1/4" to 6-1/2" x 1-1/4"	3/8"	9,000	4	
954328	WS6.4.15 X 3/8"	6-1/4" to 6-1/2" x 1-1/2"	3/8"	9,000	4	
954329	WS6.4.2 X 3/8"	6-1/4" to 6-1/2" x 2"	3/8"	9,000	4	
954330	WS71 X 3/8"	6-5/8" to 7-1/4" x 1"	3/8"	8,900	4	
954331	WS71.25 X 3/8"	6-5/8" to 7-1/4" x 1-1/4"	3/8"	8,900	4	
954332	WS71.5 X 3/8"	6-5/8" to 7-1/4" x 1-1/2"	3/8"	8,900	4	
954333	WS72 X 3/8"	6-5/8" to 7-1/4" x 2"	3/8"	8,900	4	
954336	WS81 X 3/8"	7-3/4" to 8-1/4" x 1"	3/8"	7,020	4	
954337	WS81.25 X 3/8"	7-3/4" to 8-1/4" x 1-1/4"	3/8"	7,020	4	
954338	WS81.5 X 3/8"	7-3/4" to 8-1/4" x 1-1/2"	3/8"	7,020	4	
954339	WS82X 3/8"	7-3/4" to 8-1/4" x 2"	3/8"	7,020	4	

PACIFIC HYDRO™ STEEL THICKER TOP PLATE SANITARY WELL "SUPER SEALS"

Part Number	Model Number	Size Casing I.D. X Drop Pipe	Top Plate Thickness	Working Load (Lbs.)	Weight (Lbs.)	List Price Each
954223	WS62	5-3/4" to 6-1/4" x 2"	1/2"	9250	5.5	See separate price list
954224	WS62.5	5-3/4" to 6-1/4" x 2-1/2"	1/2"	9250	5.4	
954225	WS63	5-3/4" to 6-1/4" x 3"	5/8"	17,000	5.8	
954239	WS82	7-3/4" to 8-1/4" x 2"	5/8"	16,500	9.0	
954240	WS82.5	7-3/4" to 8-1/4" x 2-1/2"	3/4"	33,000	15.0	
954241	WS83	7-3/4" to 8-1/4" x 3"	3/4"	33,000	12.85	
954242	WS84	7-3/4" to 8-1/4" x 4"	1"	38,000	13.5	
954248	WS102	9-3/4" to 10-1/4" x 2"	5/8"	16,000	18.0	
954249	WS102.5	9-3/4" to 10-1/4" x 2-1/2"	3/4"	31,000	27.4	
954250	WS103	9-3/4" to 10-1/4" x 3"	1"	39,000	25.9	
954259	WS123	11-3/4" to 12-1/4" x 3"	1"	33,000	36.5	
954260	WS124	11-3/4" to 12-1/4" x 4"	1"	33,000	34.2	

- Custom sizes available. Contact factory for quotation. Also available manufactured from stainless steel.

PACIFIC HYDRO™ STEEL JET WELL SEALS

Part Number	Model Number	Size Casing I.D. X Drop Pipe	Weight (Lbs.)	List Price Each
954100	JS41.75	4" to 4-1/4" x 1" x 3/4"	2	See separate price list
954101	JS41.1	4" to 4-1/4" x 1" x 1"	2	
954102	JS41.25.1	4" to 4-1/4" x 1-1/4" x 1"	2	
954105	JS51.25.1	5" to 5-1/4" x 1-1/4" x 1"	3	
954107	JS51.5.1.25	5" to 5-1/4" x 1-1/2" x 1-1/4"	3	
954110	JS61.1	5-3/4" to 6-1/4" x 1" x 1"	4	
954111	JS61.25.1	5-3/4" to 6-1/4" x 1-1/4" x 1"	4	
954112	JS611.251.25	5-3/4" to 6-1/4" x 1-1/4" x 1-1/4"	4	
954114	JS61.5.1	5-3/4" to 6-1/4" x 1/2" x 1"	4	
954116	JS61.5.1.25	5-3/4" to 6-1/4" x 1-1/2" x 1-1/4"	4	
954120	JS71.25.1	6-5/8" to 7-1/4" x 1-1/4" x 1"	5	
954123	JS81.25.1	7-3/4" to 8-1/4" x 1-1/4" x 1"	8	
954124	JS81.25.1.25	7-3/4" to 8-1/4" x 1-1/4" x 1-1/4"	4	
954125	JS81.5.1.25	7-3/4" to 8-1/4" x 1-1/2" x 1-1/4"	8	
954126	JS81.5.1.5	7-3/4" to 8-1/4" x 1-1/2" x 1-1/2"	8	

- Custom sizes available. Contact factory for quotation. Also available manufactured from stainless steel.

WELL SEALS



OVER THE TOP CAST IRON SANITARY WELL SEALS

- Three stainless steel cup point set screws
- Seals have 1/2" vent hole as standard
- Positive Buna-N-Seal

Part Number	Model Number	Size Casing I.D. I.D. X Drop Pipe	Top Plate Thickness	Working Load (Lbs.)	Weight (Lbs.)	List Price Each
952620	OTT4.1	4-1/2" X 1"	3/4"	6,000	0.9	See separate price list
952622	OTT4.1-1/4	4-1/2" X 1-1/4"	3/4"	6,000	0.9	
952626	OTT4.1.2	4-1/2" X 2" Offset	3/4"	6,000	1.0	

OVER THE TOP ALUMINUM SANITARY WELL SEALS

- Features:
- Cast Aluminum Alloy 319 — will not warp or crack
 - Three square head stainless steel cup point set screws
 - Seals have 1/2" vent hole as standard
 - Machined drop pipe seat with positive Buna-N-Seal

Part Number	Model Number	Size Casing I.D. I.D. X Drop Pipe	Top Plate Thickness	Working Load (Lbs.)	Weight (Lbs.)	List Price Each
952640	OTT67.1	6-5/8" -7" x 1"	1"	24,000	3.0	See separate price list
952642	OTT67.1 1/4"	6-5/8" -7" x 1-1/4"	1"	24,000	3.0	
952644	OTT67.1 1/2"	6-5/8" -7" x 1-1/2"	1"	24,000	3.0	
952646	OTT67.2	6-5/8" -7" x 2"	1"	24,000	3.0	
952650	OTT8.1	8-5/8" x 1"	1-1/4"	26,000	5.2	
952652	OTT8.1 1/4"	8-5/8" x 1-1/4"	1-1/4"	26,000	5.2	
952654	OTT8.1 1/2"	8-5/8" x 1-1/2"	1-1/4"	26,000	5.2	
952656	OTT8.2	8-5/8" x 2"	1-1/4"	26,000	5.2	
952657	OTT8.2 1/2"	8-5/8" x 2-1/2"	1-1/4"	26,000	5.1	
952658	OTT8.3	8-5/8" x 3"	1-1/4"	26,000	5.1	
952660	OTT10.1	10-3/4" x 1"	1-1/4"	30,000	8.3	
952662	OTT10.1 1/4"	10-3/4" x 1-1/4"	1-1/4"	30,000	8.3	
952664	OTT10.1 1/2"	10-3/4" x 1-1/2"	1-1/4"	30,000	8.2	
952666	OTT10.2	10-3/4" x 2"	1-1/4"	30,000	8.2	
952668	OTT10.2 1/2"	10-3/4" x 2-1/2"	1-1/4"	30,000	8.1	
952669	OTT10.3	10-3/4" x 3"	1-1/4"	30,000	8.1	

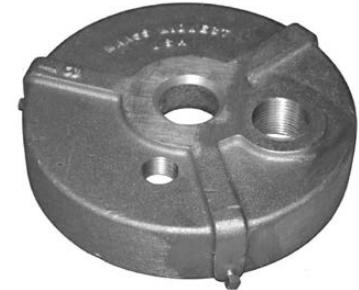

TOOL AND THREAD COMPOUNDS

BLACK FLAG™ WASP AND HORNET KILLER

- Features:
- Powerful 15' stream
 - Non-conductive
 - Kills on contact
 - EPA registered all 50 states

Part Number	Weight Per Can	Standard Pkg. Quantity	List Price Each
927650	12 oz.	12 cans	See separate price list



JET LUBE 21

- Features:
- Recommended for drill collars, drill pipes, and threading operations
 - Can be used throughout drill string
 - Contains copper and graphite
 - Will not wash-out under severe conditions
 - Galling and seizing resistant

Part Number	Pail Size	Weight (Lbs.)	List Price Each
927730	1 gal.	10	See separate price list
927735	2 gal.	20	
927740	5 gal.	50	



JET LUBE BULLSEYE

- Features:
- Excellent thread compound for sensitive drilling situations
 - Non-metallic
 - Petroleum hydrocarbon free
 - Biodegradable, vegetable oil based

Part Number	Pail Size	Weight (Lbs.)	List Price Each
927760	1 gal.	10	See separate price list



WELL SEALS
TOOL & THREAD COMPOUNDS

TOOL AND THREAD COMPOUNDS



JET LUBE Z-50

Features:

- Recommended for tool joints, collars and coring joints
- 50% powdered metallic zinc
- Contains H₂S inhibitors
- Brushable to 10°F

Part Number	Pail Size	Weight (Lbs.)	List Price Each
927770	3.5 gal.	35	See separate price list



JET LUBE PITLESS ADAPTER LUBE

Features:

- USDA H-1 food grade anti seize technology
- Antibacterial antifungal lubricant
- Water resistant

Part Number	Standard Package Quantity	Weight Per Can	List Price Each
927790	12	12 oz.	See separate price list



ECO-SAFE™

Features:

- Non-metallic
- Provides lubrication and protection to 500° F
- High temperature calcium complex base grease
- Resistant to water wash off
- Especially effective for high pH muds

Part Number	Pail Size	Weight (Lbs.)	List Price Each
927765	1 gal.	10	See separate price list



WELL-GUARD®

Features:

- High-performance thread compound
- Petroleum hydrocarbon free product
- Designed for monitor well and environmentally sensitive drilling applications
- Brushable from -10° F to 400° F

Part Number	Pail Size	Weight (Lbs.)	List Price Each
927775	1 gal.	10	See separate price list



JET LUBE KOPR KOTE

Features:

- Contains no lead or zinc
- NSF registered No. 120923
- Provides shield for metal to metal contact
- Recommended for thread connections
- Maximum protection in demanding environments
- Provides lubrication and protection to 450°F

Part Number	Brush Top Can Weight (lbs.)	List Price Each
927700	1/2	See separate price list
927705	1	

Part Number	Pail Size	Weight (lbs.)	List Price Each
927745	1 Gal.	11	See separate price list
927750	2 Gal.	21	
927755	5 gal.	52	

#2 DOPE BRUSH

Features:

- 16" heavy wooden handle
- 1-18" tapered
- Bristles designed for uniform compound applications
- Plastic hand guard

Part Number	Pieces Per Box	Weight (Oz.)	List Price Each
927780	12	8	See separate price list

PLASTIC PAIL OPENER

Features:

- Lightweight aluminum design
- Equipped with hammer face to re-attach lid
- Opens 1, 2, 3 1/2 and 5 gallon plastic pail

Part Number	Quantity	Weight (Oz.)	List Price Each
927785	IND.	12	See separate price list



PRESSURE GAUGES

Features:

- Ametek
- With steel case/brass stem, 1/8" orifice
- Imported

Part Number	Diameter (Inches)	Pressure Range (PSI)	Pressure Connection (Ins.)	Approx. Weight (Lbs.)	List Price Each
940069	2	0-100#	1/4	.4	See separate price list

Features:

- Midwest Lead free ($\leq 0.25\%$ lead content)
- With steel case/brass stem, 1/8" orifice

Part Number	Diameter (Inches)	Pressure Range (PSI)	Pressure Connection (Ins.)	Approx. Weight (Lbs.)	List Price Each
940070	2	0-100#	1/4	.4	See separate price list
940068	2	0-200#	1/4	.4	See separate price list



BACK MOUNTED GAUGES

Part Number	Diameter (Inches)	Pressure Range (PSI)	Pressure Connection (Ins.)	Approx. Weight (Lbs.)	List Price Each
940071	2	0-100#	1/4	.4	See separate price list
940072	2	0-200#	1/4	.4	See separate price list



PRESSURE GAUGE LIQUID-FILLED MIDWEST - 2-1/2"

Features:

- Stainless steel case
- Liquid filled to reduce vibrations
- Lead free ($\leq 0.25\%$ lead content)
- Brass stem
- Imported

Part Number	Model Number	Diameter (Inches)	Pressure Range (PSI)	Pressure Connection (Ins.)	Approx. Weight (Lbs.)	List Price Each
640202	PHLF100	2-1/2"	0-100#	1/4	.42	See separate price list
640203	PHLF200	2-1/2"	0-200#	1/4	.42	See separate price list



2" LIQUID FILLED GAUGES

Features:

- Stainless steel case
- Liquid filled to reduce vibrations
- Lead free ($\leq 0.25\%$ lead content)
- Brass stem
- Imported

Part Number	Model Number	Diameter (Inches)	Pressure Range (PSI)	Pressure Connection (Ins.)	Approx. Weight (Lbs.)	List Price Each
940187	PGLF1002	2	0-100#	1/4	.4	See separate price list
940189	PGLF2002	2	0-200#	1/4	.4	See separate price list



2" LIQUID FILLED BACK MOUNTED GAUGES

Features:

- Lead free ($\leq 0.25\%$ lead content)
- Stainless steel case
- Imported
- Liquid filled to reduce vibrations
- Brass stem

Part Number	Diameter (Inches)	Pressure Range (PSI)	Pressure Connection (Ins.)	Approx. Weight (Lbs.)	List Price Each
940191	2	0-100#	1/4	.4	See separate price list
940193	2	0-200#	1/4	.4	See separate price list

2 1/2" LIQUID FILLED BACK MOUNTED GAUGES

Features:

- Lead free ($\leq 0.25\%$ lead content)
- Stainless steel case
- Liquid filled to reduce vibrations
- Imported

Part Number	Diameter (Inches)	Pressure Range (PSI)	Pressure Connection (Ins.)	Approx. Weight (Lbs.)	List Price Each
940073	2-1/2	0-100#	1/4	.45	See separate price list
940074	2-1/2	0-200#	1/4	.45	See separate price list

PRESSURE GAUGES



LIQUID FILLED GAUGES

- Features:
- Stainless steel case
 - Lead free ($\leq 0.25\%$ lead content)
 - Brass stem
 - USA Made



Part Number	Model Number	Diameter (Inches)	Pressure Range (PSI)	Pressure Connection (Ins.)	Approx. Weight (Lbs.)	List Price Each
940204	PGL30	2-1/2	0-30#	1/4	.50	See separate price list
940206	PGL60	2-1/2	0-60#	1/4	.50	
940208	PGL100	2-1/2	0-100#	1/4	.50	
940210	PGL160	2-1/2	0-160#	1/4	.50	
940212	PGL200	2-1/2	0-200#	1/4	.50	
940214	PGL300	2-1/2	0-300#	1/4	.50	
940216	PGL400	2-1/2	0-400#	1/4	.50	
940218	PGL600	2-1/2	0-600#	1/4	.50	
940220	PGL1000	2-1/2	0-1000#	1/4	.50	
940222	PGL60	4	0-60#	1/4	.50	
940224	PGL100	4	0-100#	1/4	1.90	
940226	PGL160	4	0-160#	1/4	1.90	
940228	PGL200	4	0-200#	1/4	1.90	
940230	PGL300	4	0-300#	1/4	1.90	
940232	PGL400	4	0-400#	1/4	1.90	
940234	PGL600	4	0-600#	1/4	1.90	
940236	PGL1000	4	0-1000#	1/4	1.90	

• NOTE: Other size pressure gauges on request

2-1/2" LIQUID FILLED BACK MOUNTED GAUGES

- Features:
- Lead free ($\leq 0.25\%$ lead content)
 - Brass stem
 - Stainless steel case
 - USA made



Part Number	Model Number	Diameter (Inches)	Pressure Range (PSI)	Pressure Connection (Ins.)	Approx. Weight (Lbs.)	List Price Each
940255	PGL30	2-1/2	0-30#	1/4	.50	See separate price list
940256	PGL60	2-1/2	0-60#	1/4	.50	
940257	PGL100	2-1/2	0-100#	1/4	.50	
940259	PGL200	2-1/2	0-200#	1/4	.50	
940260	PGL300	2-1/2	0-300#	1/4	.50	
940261	PGL400	2-1/2	0-400#	1/4	.50	
940263	PGL1000	2-1/2	0-1000#	1/4	.50	

2-1/2" LIQUID FILLED VACUUM GAUGES

- Features:
- Stainless steel case
 - 1/4" bottom



Part Number	Model Number	Description	List Price Each
940250	PGL-30	25.901 -30/+30 PSI	See separate price list

4 1/2" WATER LEVEL GAUGE

- Features:
- Used in conjunction with airline
 - Steel case
 - Adjustable dial to permit reading water level in feet
 - Phosphor bronze bourdon tube

CA566	Model Number	Depth Range	Connection (Inches)	Approx. Weight (Lbs.)	List Price Each
940238	CA566	0-390 ft.	1/4	2.0	See separate price list

2" DRY GAUGE - BOTTOM MOUNT: MADE IN USA

Part Number	Description	List Price Each
640160	0-100"	See separate price list

GAUGE PANEL MOUNTING CLAMP

Part Number	Description	List Price Each
940242	Designed for back connecting gauges	See separate price list

• NOTE: Other size pressure gauges on request



ACCESSORIES

SQUARE D PRESSURE SWITCHES

Part Number	Type	Pressure Range (PSI)	Description	Pressure Connection	Approx. Weight (Lbs.)	List Price Each
940024	FSG2	20/40	Standard switch	1/4"	1.3	See separate price list
940032	FSG2	30/50	Standard switch	1/4"	1.3	
940026	FSG2	40/60	Standard switch	1/4"	1.3	
940133	FSG2J2oMI	20/40	Manual cut-off	1/4"	2	
940134	FSG2J2oMI	30/50	Manual cut-off	1/4"	2	
940135	FSG2J2oMI	40/60	Manual cut-off	1/4"	2	
940023	FSG2MIP	30/50	Manual cut-off lever-P.Plug	1/4"	1.5	
940054	FSG2M4	20/40	Low pressure cut-off	1/4"	1.5	
940028	FSG2M4	30/50	Low pressure cut-off	1/4"	1.5	
940055	FSG2M4	40/60	Low pressure cut-off	1/4"	1.5	
940130	FRG2	50/30	Reverse Action	1/4"	1.3	
940034	FSG52J25	60/80	Higher Cut In (max. 60 psi)	1/4"	1.3	
940025	FSG52J33	50/70	Higher Cut In (max. 60 psi)	1/4"	1.3	
940030	FSG2P	20/40	With Pulsation Plug	1/4"	1.3	
940031	FSG2P	30/50	With Pulsation Plug	1/4"	1.3	
940029	FSG2P	40/60	With Pulsation Plug	1/4"	1.3	
940136	FSW2	20/40	Corrosion Resistant NEMA3R	1/4"	2	
940137	FSW2	30/50	Corrosion Resistant NEMA3R	1/4"	2	
940138	FSW2	40/60	Corrosion Resistant NEMA3R	1/4"	2	
940139	GSW	20/40	Heavy Duty Nema 4	1/4"	2.2	
940140	GSW	30/50	Heavy Duty Nema 4	1/4"	2.2	
940141	GSW	40/60	Heavy Duty Nema 4	1/4"	2.2	
940022	Form P	---	Nylon Pulsation Plug		0.1	
940056	FSG-PC241	---	Replacement Contact Kit		0.2	
940057	FYG2	20/40	Higher HP. 80 PSI	1/4"	1.3	
940058	FYG2	30/50	Higher HP. 80 PSI	1/4"	1.3	
940059	FYG2	40/60	Higher HP. 80 PSI	1/4"	1.3	
940039	GSG2	20/40	Light Industrial-Air & Water	1/4"	2	
940041	GSG2	30/50	Light Industrial-Air & Water	1/4"	2	
940040	GSG2	40/60	Light Industrial-Air & Water	1/4"	2	
940042	GSG2	60/80	Light Industrial-Air & Water	1/4"	2	
940045	GHG2	30/50	Commercial Higher Pressure	1/4"	2.2	
940046	GHG2	40/60	Commercial Higher Pressure	1/4"	2.2	
940047	GHG2	60/80	Commercial Higher Pressure	1/4"	2.2	
940048	GHG2	80/100	Commercial Higher Pressure	1/4"	2.2	
940043	GHG2R	100/80	Reversing Higher Pressure	1/4"	2.2	

- Lead Free: ≤ .025% Lead Content

SQUARE D FLOAT SWITCHES | Class 9036

Part Number	Type	Description	Approx. Weight	List Price Each
940142	DG2	Float Close On Liquid Rise	2	See separate price list
940143	DG2R	Float Reversing Open On Liquid Rise	2	
940146	GG2	Float Close On Liquid Rise	2	
940147	GG2R	Float Reversing Open On Liquid Rise	2	
940148	FG30	Float Close On Liquid Rise	2	

- Float not included

SQUARE D FLOAT SWITCHES | Class 9037

Part Number	Square D Part #	Float Positions from Front of Switch	Float Rod Angle	Approx. Water Min.	Level Change Max.	Operations	List Price Each
940060	9037HG33	Right	45	2"	5"	Close On Liquid Rise	See separate price list
940062	9037HG34	Left	45	2"	5"	Close On Liquid Rise	

- Note:
- Other Square D switches, switch accessories, and pump safety switches available on request.
- Float not included

SQUARE D GENERAL DUTY SAFETY SWITCHES

Part Number	Type	Description	Pressure Connection	Approx. Weight	List Price Each
970001	D211N	Fusible GD 120/240V 30A 2P NEMA1	1/4"	.95 lbs.	See separate price list
970002	D211NRB	Fusible GD 120/240V 30A 2P NEMA3R	1/4"	.95 lbs.	
970005	222N	Fusible GD 240V 60A 2P NEMA1	1/4"	.95 lbs.	



ACCESSORIES

ALDERON MECHANICAL PUMP SWITCHES



Features:

- High amp rating eliminates 1/2 horsepower float switches
- Patented mechanical design eliminates hazardous mercury
- PVC float housing
- Heavy duty cable, 14 gauge, 2 conductor cable
- Omni-directional, not sensitive to rotation or turbulence
- Adjustable pumping range
- UL Listed

Part Number	Model Number	Description	Cord Length	Voltage	List Price Each
969005	7300	Piggyback, pump down	10'	120/230VAC	See separate price list
969010	7055	Piggyback, pump down	20'	120/230VAC	
969015	7304	Piggyback, pump up	10'	120/230VAC	
969020	7372	No plug, pump up	10'	120/230VAC	
969025	7069	No plug, pump up	15'	120/230VAC	

ALDERON SIMPLEX CONTROL AND ALARM PANELS

Features:

- Big switch control panel utilizes a pump switch and a control float activating a high water alarm
- Hand/off/auto
- Alarm light
- Alarm buzzer - auto reset
- Green pump-run indicator light
- NEMA 4X
- UL Listed



Part Number	Model Number	Description	Voltage	List Price Each
969030	7173	Single Piggyback/8" to 22" pumping range	120/230VAC	See separate price list
969035	7185	Single Piggyback/2" to 60" pumping range	120VAC	
969040	7186	Single Piggyback/2" to 60" pumping range	1230VAC	

ALDERON 7001 TANK ALARM SYSTEM

Features:

- Flashing light and buzzer
- Unique auto reset
- Battery backup protection
- Alarm auxiliary contact offers flexibility to remote sources
- Indicator lights/power and alarm status
- UL and CSA listed



Part Number	Model Number	Description	List Price Each
965040	7001	Type 1 Enclosure, high level 15' cord	See separate price list

ALDERON 7008 WATER SPOTTER, FLOOD SENSOR

Features:

- Works in conjunction with 7001 Tank Alarm

Part Number	Model Number	Description	Cord Length	Voltage	List Price Each
965041	7008	Flood Sensor	15'	120VAC	See separate price list

ALDERON 7004 TANK ALARM SYSTEM

Features:

- Automatic buzzer reset
- REc polycarbonate beacon
- 100db alarm buzzer
- UL and CSA listed



Part Number	Model Number	Description	List Price Each
965045	7004	NEMA 4X, Indoor/Outdoor high level 15'	See separate price list

ACCESSORIES

HEAT SHRINK SPLICE KITS

These kits feature thick wall, self-sealing heat shrinkable tubing which provides quick, moisture-proof splicing in the field. Kits are available in 2, 3 and 4 wire versions.

Features:

- Professional grade
- Splices made using standard wire crimping tool
- Permanently flexible sealant
- Wide range of sealing capability - will cover a large diameter connection and still effectively seal down to a small diameter cable
- Easy activation with heat source
- Excellent Dielectric strength
- 3M material USA made
- Highly resistant to moisture, fungus and weathering



Part Number	Description	List Price Each
942001	Heat Shrink Kit A-2 for 10, 12, 14 gauge wire (2 wire, black)	See separate price list
942002	Heat Shrink Kit A-2C for 10, 12, 14 gauge wire (2 wire, clear)	
942003	Heat Shrink Kit A-3 for 10, 12, 14 gauge wire (3 wire, black)	
942004	Heat Shrink Kit A-3C for 10, 12, 14 gauge wire (3 wire, clear)	
942005	Heat Shrink Kit A-8 for 8 gauge wire (4 wire, black)	
942006	Heat Shrink Kit A-8C for 8 gauge wire (4 wire, clear)	
942008	Heat Shrink Kit A-4 for 10, 12, 14 gauge wire (4 wire, black)	
942009	Heat Shrink Kit A-4C for 10, 12, 14 gauge wire (4 wire, clear)	
942012	Master Pack Heat Shrink Kit A-12C for 10, 12, 14 gauge wire (12 pks, clear)	
942022	Heat Shrink Kit A-4, for 6 gauge wire (4 wire, black)	
942023	Heat Shrink Kit A-4,6C for 6 gauge wire (4 wire, clear)	
942024	Heat Shrink Kit A-4,4 for 4 gauge wire (4 wire, black)	
942025	Heat Shrink Kit A-4,4C for 4 gauge wire (4 wire, clear)	
942026	Heat Shrink Kit A-4,2 for 2 gauge wire (4 wire, black)	
942027	Heat Shrink Kit A-4,2C for 2 gauge wire (4 wire, clear)	
942028	Heat Shrink Kit A-4,10 for 1/0 gauge wire (4 wire)	

STANDARD CLEAR AND BLACK TUBING

Part Number	Tubing Size	Color	Wire Size	Bag Quantity	Bag Weight (Lbs.)	List Price Each
942029	3/8" x 3"	Clear	#10-12-14	50	.52	See separate price list
942030	3/8" x 3"	Clear	#10-12-14	100	.27	
942033	3/8" x 3"	Black	#10-12-14	50	.19	
942034	3/8" x 3"	Black	#10-12-14	100	.36	

BUTT SPLICE CONNECTORS

Part Number	Wire Gauge	Description	Quantity Per Package	List Price Each
942007	10-12-14	B-1210	50	See separate price list
942032	10-12-14	B-1210	100	
942040	8	BC-8	50	
942041	6	BC-6	25	
942042	4	BC-4	25	
942043	2	BC-2	1	
942044	1/0	BC-10	1	
942045	2/0	BC-20	1	



UNDERGROUND CABLE SPLICE KIT

Features:

- For direct burial of 14 to 8 gauge multi-conductor feeder cable (copper wire only)
- Easy activation with heat source
- Will accommodate 2 or 3 conductors with ground
- UL and CSA listed

Part Number	Description	List Price Each
942010	Markel UF splice kit	See separate price list



ACCESSORIES

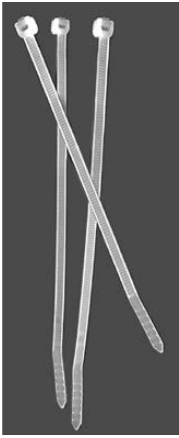

IDEAL ELECTRICAL CABLE TIES

- Features:
- For tying and bundling applications

Part Number	Length	Size	Package Quantity	List Price Each
942060	8.1"	1/16" to 2-3/16"	100	See separate price list
942061	14.5"	1/16" to 4"	100	

IDEAL SILICONE-FILLED WIRE CONNECTORS

- Features:
- Pre-filled silicone, wire nut connectors
 - UL Listed to 486D for use in damp/wet conditions
 - Weatherproof™ for interior or exterior locations
 - Easy to apply, pre-filled twist-on connectors



Part Number	Model Number	Wire Range	Quantity (Per Carton)	List Price Each
942054	62	18 - 8AWG	100	See separate price list
942056	63	16 - 6AWG	100	

WELL CASING ELECTRICAL GROUNDING CLAMP Patented (Patent No. D414744)

- Features:
- Meets UL and CSA Standards for the bonding of ground wire to metal well casing
 - Fits well casing 3" through 10"
 - Easily installed under the well cap
 - Required by National Electric Code
 - Suitable for 14 to 8 gauge copper wire
 - Cast brass material
 - Made in USA



Part Number	Model Number	Well Casing	Wire Gauge	List Price Each
952900	M1	3" - 10"	14-8	See separate price list

SURGE ARRESTOR

- Features:
- Designed to protect motors and controls from voltage surges
 - Surges in excess of 500 volts are shunted to ground
 - Easily installed in conjunction with pressure switch or control box
 - Can be used with either 2 or 3 wire motors



Part Number	Quantity Per Package	List Price Each
942020	1	See separate price list

SELF-FUSING SILICONE TAPE

- Features:
- No adhesive needed
 - No torch needed
 - No need for heat shrinks
 - Insulates 400V/7 MIL
 - Waterproof
 - UL Listed
 - Maintains all characteristics and resistances from -65° up to 500°F
 - Made in USA



Part Number	Description	Size	List Price Each
943000	Tape Dispenser	1" X 10"	See separate price list
943100	Refill - Black - Triangular	1" X 12"	
943300	Refill - Clear - Triangular	1" X 12"	
943500	30 MIL Black - Rectangular	2" X 30"	

ALL WEATHER ELECTRICAL TAPE

- Features:
- Requires no heat, moisture or other matter to be effective
 - No more than 600V
 - No more than 176°F (80°C)



Part Number	Size	Description	Approved	List Price Each
942011	3/4" x 60'	7.5 mil thickness	UL	See separate price list
942016	2" x 100'	10 mil thickness - pipe wrap		

ACCESSORIES



3M™ SUPER 33 + VINYL ELECTRICAL TAPE

Features:

- UL Listed; UL 510 Standard “Insulating Tape”
- PVC tape with high dielectric strength, flame retardant and conformable
- Excellent resistance to abrasion, moisture, alkalis, acid, copper, corrosion, varying weather conditions, and sunlight
- 7 mil thickness



Part Number	Size	Description	Carton Quantity	List Price Each
942017	3/4" x 66'	Up to 600V & 220°F (105°C)	10	See separate price list

3M™ 2242 LINERLESS TAPE

Features:

- Multi-purpose insulating tape
- Rated to 194°F (90°C)
- Excellent for use in splicing and terminating wires and cables
- Flame resistant
- Moisture-sealing and insulating
- Linerless Ethylene Propylene Rubber
- For motor leads and wire and cable jacket repair

Part Number	Size	Description	Carton Quantity	List Price Each
942015	3/4"	30 MIL Thickness	24	See separate price list

PTFE THREAD SEAL TAPE | Gray

Features:

- Prevents galling, seizing and corrosion
- Temperature range from -450°F to 550°F
- For coarse stainless steel threads
- Made in USA



Part Number	Size	Description	Qty. per Case	Weight	List Price Each
942072	1/2" x 520"	Gray thread seal tape	144	10 Lbs.	See separate price list

PTFE THREAD SEAL TAPE | White

Features:

- Made from 100% virgin PTFE
- May be used on stainless steel
- No pigments or additives
- Temperature range from -450°F to 550°F



Part Number	Size	Description	Qty. per Case	Weight	List Price Each
942082	1/2" x 1296"	White thread seal tape	250	22 lbs.	See separate price list
942086	3/4" x 1296"	White thread seal tape	150	16 lbs.	

1/4" POLYPROPYLENE BRAIDED ROPE

Features:

- 1000 lb. tensile strength
- Made in USA
- Retains flexibility at all temperatures
- Completely rot and mildew proof
- Spool manufactured from plastic

Part Number	Length (Feet)	Weight (Lbs.)	List Price Each
941700	500	4.5	See separate price list
941701	1000	8.5	
941702	3000	25.3	



ACCESSORIES



POLYPROPYLENE THREE STRAND TWISTED ROPE

Features:

- Yellow
- Spool manufactured from wood or plastic
- 1/4" - 1125 lb. tensile strength
- 3/8" - 2500 lb. tensile strength

Part Number	Size	Length (Feet)	Spool Material	Weight (Lbs.)	List Price Each
941705	1/4"	1200	Plastic	13	See separate price list
941708	3/8"	600	Wood	13	
941710	3/8"	1200	Wood	37	



PRESSURE SNUBBER

Features:

- Brass piston type
- Resists clogging
- Five different size pistons included with each snubber

Part Number	Model Number	Description	Connection	Approx. Weight	List Price Each
940240	PS1325	Pressure snubber	1/4"	4 oz.	See separate price list



370 Relief

RELIEF VALVES

Features:

- Brass, spring loaded pressure relief valve for shallow and deep well pumps
- Lead Free: ≤ .025% Lead Content

Part Number	Pipe Size (Inches)	Pressure Setting	Approx. Weight (Lbs.)	List Price Each
934004	1/2 x 1/2	75 lbs.	.5	See separate price list
934005	3/4 x 1/2	75 lbs.	.5	
935005	3/4 x 1/2	100 lbs.	1.20	



5370

RELIEF VALVES

Features:

- Adjustable pressure setting, 10 to 125 PSI
- Factory set at 75 PSI

Part Number	Pipe Size (Inches)	Approx. Weight (Lbs.)	List Price Each
934002	3/4 x 3/4	1.20	See separate price list



645

SERIES 645 AIR VALVES

Features:

- Light spring

Part Number	Size (Inches)	Approx. Weight (Ounces)	List Price Each
940006	1/8	1 oz.	See separate price list
940009	1/4	1 oz.	
549004	CORE ONLY	--	
549008	CAP ONLY	--	

SERIES 655 AIR VALVES

Features:

- No spring

Part Number	Size (Inches)	Approx. Weight (Ounces)	List Price Each
940010	1/8	1 oz.	See separate price list
940011	1/4	1 oz.	
549006	CORE ONLY	--	

SUBMERSIBLE CABLE GUARD

Features:

- Use to centralize pipe in well casing

Part Number	For Casing Size (Inches)	Weight Each (Ounces)	List Price Each
934010	4-5-6	2	See separate price list



934010

ACCESSORIES

SUBMERSIBLE WRAP AROUND CABLE GUARD

Features:

- Fits 1" drop pipe
- Clamp device adjusts to drop pipe
- Two large holes for wire and safety rope

Part Number	For Casing Size (Inches)	Weight Each (Ounces)	List Price Each
934014	4-5-6	2	See separate price list

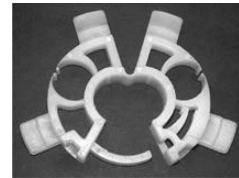

934014

TORQUE ARRESTORS

Features:

- Remains flexible under extreme
- Supplied with two stainless steel clamps cold temperatures
- Fits 1-1 1/2" drop pipe
- Expandable rubber fits 4-8" casing
- Individually bagged

Part Number	Trade Number	Description	Weight Each (Lbs.)	List Price Each
934011	STA-48	Two Halves	2	See separate price list



STA-48

BLEEDER VALVES

Features:

- Used to supply air to pressure tanks

Part Number	Pipe Size (Inches)	Material	Weight Each (Ounces)	List Price Each
922792	3/4	Brass	3	See separate price list
941648	1	Rubber	2	



539

68 SERIES IDEAL STANT®

- 200 series band and housing
- 400 series 5/16" hex head and Screw

Part Number	Diameter Range (Inches)		Standard Package	Standard Carton	Pounds per 100	List Price Each
	Min.	Max.				
446806	3/8	7/8	10	200	2	See separate price list
446810	1/2	1-1/16	10	500	4	
446812	1/2	1-1/4	10	500	5	
446816	3/4	1-1/2	10	500	5	
446820	3/4	1- 3/4	10	500	5	
446824	1	2	10	500	6	
446828	1-5/16	2-1/4	10	500	6	
446832	1-5/8	2-1/2	10	500	7	
446836	3/4	2-3/4	10	200	7	
446840	1	3	10	200	8	
446844	1-1/4	3-1/4	10	200	8	
446848	1-1/2	3-1/2	10	200	8	
446852	1-3/4	3-3/4	10	100	8	
446856	2	4	10	100	10	
446864	2-1/2	4-1/2	10	100	11	
446872	3	5	10	100	11	
446880	3-1/2	5-1/2	10	100	14	
446888	4	6	10	100	14	
446896	4-1/2	6-1/2	10	100	14	
446104	5	7	10	100	14	
463188	2	12-1/4	50	100	36	

ALL STAINLESS
STEEL CLAMPS U.S.
MANUFACTURED
Ideal®



69 SERIES IDEAL STANT® LOX-ON

- Unique double locking-system

Part Number	Diameter Range (Inches)		Standard Package	Standard Carton	Pounds per 100	List Price Each
	Min.	Max.				
446920	11/16	1-3/4	50	500	2	See separate price list
446932	11/16	2-5/8	50	500	2	
446972	1-3/4	5	50	500	2	

ACCESSORIES



PITCHER PUMP

Features:

- Heavy cast iron pump
- Hook for pail
- Cap can be adjusted for a wide range of handle positions

Part Number	Type of Spout	Cylinder Size (Inches)	700 Valve Leather	Base Tapped (In. IPS)	Height (Inches)	Weight (Lbs.)	List Price Each
940100	Open	3	3 x 3-1/2	1-1/4	18	19	See separate price list



AIR VOLUME CONTROLS

Part Number	Trade Number	Mfr.	Description	Case	Weight (Lbs.)	List Price Each
940061	57	Johnson	Deepwell less gauge	Noryl	0.5	See separate price list
940063	57	Ametek	Deepwell less gauge	Metal	1.5	



PLASTIC JET PUMP AIR CONTROL

Features:

- High capacity air charger fits all size tanks up to and including 82 gallon
- Easily manifolded for larger size tanks
- Easier to clean and remove snifter assembly
- Tapped 1/4 FIP

Part Number	Description	List Price Each
940086	Jet Pump Air Control	See separate price list

PLASTIC JET PUMP AIR CONTROL INSTALLATION PACKAGE

Kit Includes:

- 4' poly tubing
- Two 1/4" MIP x 1/8" barb brass adapters

Part Number	Description	List Price Each
940088	Air Control Installation Package	See separate price list

DOLE FLOW CONTROLS

DOLE FLOW CONTROLS

Features:

- Self cleaning devices, designed to deliver a constant volume of water flow output
- Flow rates maintained to $\pm 15\%$ up to pressure drops of 125 psi
- Zinc plated control body
- Lead Free: $\leq .025\%$ Lead Content



DOLE FLOW CONTROLS

Part Number	Model	Description	Flow Rate (GPM)	List Price Each
934204	GA	3/8" female x 3/8" female	0.19	See separate price list
934206	GA	3/8" female x 3/8" female	0.25	
934208	GA	3/8" female x 3/8" female	0.35	
934210	GA	3/8" female x 3/8" female	0.50	
934214	GA	3/8" female x 3/8" female	1.0	
934220	GB	1/2" female x 1/2" female	1.0	
934222	GB	1/2" female x 1/2" female	1.5	
934224	GB	1/2" female x 1/2" female	2.0	
934228	GB	1/2" female x 1/2" female	3.0	
934232	GB	1/2" female x 1/2" female	4.0	
934234	GB	1/2" female x 1/2" female	5.0	
934236	GB	1/2" female x 1/2" female	6.0	
934240	GC	3/4" female x 3/4" female	1.0	
934242	GC	3/4" female x 3/4" female	1.5	
934244	GC	3/4" female x 3/4" female	2.0	
934246	GC	3/4" female x 3/4" female	2.5	
934248	GC	3/4" female x 3/4" female	3.0	
934250	GC	3/4" female x 3/4" female	3.5	
934252	GC	3/4" female x 3/4" female	4.0	
934254	GC	3/4" female x 3/4" female	5.0	
934256	GC	3/4" female x 3/4" female	6.0	
934258	GC	3/4" female x 3/4" female	7.0	
934260	GC	3/4" female x 3/4" female	8.0	
934262	GC	3/4" female x 3/4" female	9.0	
934264	GC	3/4" female x 3/4" female	10.0	
934280	GY	3/4" male x 3/4" female	1.0	
934282	GY	3/4" male x 3/4" female	1.5	
934284	GY	3/4" male x 3/4" female	2.0	
934288	GY	3/4" male x 3/4" female	3.0	
934292	GY	3/4" male x 3/4" female	4.0	
934294	GY	3/4" male x 3/4" female	5.0	
934296	GY	3/4" male x 3/4" female	6.0	
934298	GY	3/4" male x 3/4" female	7.0	
934300	GY	3/4" male x 3/4" female	8.0	
934302	GY	3/4" male x 3/4" female	9.0	
934304	GY	3/4" male x 3/4" female	10.0	
934320	GX	1" female x 1" female	1.0	
934322	GX	1" female x 1" female	1.5	
934324	GX	1" female x 1" female	2.0	
934326	GX	1" female x 1" female	2.5	
934328	GX	1" female x 1" female	3.0	
934330	GX	1" female x 1" female	3.5	
934332	GX	1" female x 1" female	4.0	
934334	GX	1" female x 1" female	5.0	
934336	GX	1" female x 1" female	6.0	
934338	GX	1" female x 1" female	7.0	
934340	GX	1" female x 1" female	8.0	
934342	GX	1" female x 1" female	9.0	
934344	GX	1" female x 1" female	10.0	
934346	GX	1" female x 1" female	12.0	
934348	GX	1" female x 1" female	13.5	
934350	GX	1" female x 1" female	15.0	
934352	GX	1" female x 1" female	20.0	
934354	GX	1" female x 1" female	25.0	
934356	GX	1" female x 1" female	30.0	
934360	GP	1-1/4" male x 1-1/4" male	1.0	
934362	GP	1-1/4" male x 1-1/4" male	1.5	
934364	GP	1-1/4" male x 1-1/4" male	2.0	
934368	GP	1-1/4" male x 1-1/4" male	3.0	
934372	GP	1-1/4" male x 1-1/4" male	4.0	
934374	GP	1-1/4" male x 1-1/4" male	5.0	
934376	GP	1-1/4" male x 1-1/4" male	6.0	
934378	GP	1-1/4" male x 1-1/4" male	7.0	
934380	GP	1-1/4" male x 1-1/4" male	8.0	
934382	GP	1-1/4" male x 1-1/4" male	9.0	
934384	GP	1-1/4" male x 1-1/4" male	10.0	
934386	GP	1-1/4" male x 1-1/4" male	12.0	
934390	GP	1-1/4" male x 1-1/4" male	15.0	
934392	GP	1-1/4" male x 1-1/4" male	20.0	

NOTE:

- When ordering, specify part number, model type and flow rate desired. i.e.: 934214 GA - 1.0
- Other sizes available upon request.

HG FLOW CONTROL REGULATORS

Features:

- Designed to deliver a constant volume of water flow output
- Flow tolerance of +/- 15%
- Temperature range 40° to 150°F
- Quiet operation
- Zinc plated body
- Lead Free: ≤ .025% Lead Content
- NSF/ANSI 61 and CSA

HG FLOW CONTROL
REGULATORS



Part Number	Model	Size	Flow Rate (GPM)	List Price Each
934686	HGB-1.0	1/2F X 1/2F	1	See separate price list
934690	HGB-1.5	1/2F X 1/2F	1-1/2	
934694	HGB-2.0	1/2F X 1/2F	2	
934698	HGB-3.0	1/2F X 1/2F	3	
934702	HGB-4.0	1/2F X 1/2F	4	
934706	HGB-5.0	1/2F X 1/2F	5	
934708	HGB-6.0	1/2F X 1/2F	6	
934724	HGC-1.0	3/4F X 3/4F	1	
934728	HGC-1.5	3/4F X 3/4F	1.5	
934732	HGC-2.0	3/4F X 3/4F	2	
934734	HGC-2.5	3/4F X 3/4F	1-1/2	
934736	HGC-3.0	3/4F X 3/4F	3	
934738	HGC-3.5	3/4F X 3/4F	3.5	
934740	HGC-4.0	3/4F X 3/4F	4	
934744	HGC-5.0	3/4F X 3/4F	5	
934746	HGC-6.0	3/4F X 3/4F	6	
934750	HGC-7.0	3/4F X 3/4F	7	
934776	HGX-1.0	1F X 1F	1	
934777	HGX-2.0	1F X 1F	2	
934778	HGX-2.5	1F X 1F	2-1/2	
934780	HGX-3.0	1F X 1F	3	
934782	HGX-3.5	1F X 1F	3-1/2	
934784	HGX-4.0	1F X 1F	4	
934790	HGX-5.0	1F X 1F	5	
934792	HGX-6.0	1F X 1F	6	
934796	HGX-7.0	1F X 1F	7	
934798	HGX-8.0	1F X 1F	8	
934800	HGX-9.0	1F X 1F	9	
934802	HGX-10.0	1F X 1F	10	
934804	HGX-12.0	1F X 1F	12	
934808	HGX-13.5	1F X 1F	13-1/2	
934810	HGX-15.0	1F X 1F	15	
934814	HGX-20.0	1F X 1F	20	
934818	HGX-25.0	1F X 1F	25	
934822	HGX-30.0	1F X 1F	30	
934840	HGP-5.0	1-1/4 M X 1-1/4 M	5	
934842	HGP-6.0	1-1/4 M X 1-1/4 M	6	
934846	HGP-7.0	1-1/4 M X 1-1/4 M	7	
934848	HGP-8.0	1-1/4 M X 1-1/4 M	8	
934850	HGP-9.0	1-1/4 M X 1-1/4 M	9	
934852	HGP-10.0	1-1/4 M X 1-1/4 M	10	
934854	HGP-12.0	1-1/4 M X 1-1/4 M	12	
934860	HGP-15.0	1-1/4 M X 1-1/4 M	15	
934864	HGP-20.0	1-1/4 M X 1-1/4 M	20	

CHARGE AIR 2000

CHARGE AIR 2000 - UNIVERSAL AIR CHARGING SYSTEM FOR HYDROPNEUMATIC TANKS

Features:

- Dual voltage switch system (120 - 240 VAC) allows for easy voltage selection
- Auto ranging solid state liquid level control
- Oil-less long life high capacity compressor
- Adjustable pressure switch (40 - 110 PSI)
- One year warranty
- Strain relief on probe connection
- Rodent proof air vents
- Stainless steel fasteners and gold zinc plating
- Heavy gauge UV resistant cover
- Direct access terminal block
- Improved air lines to handle higher temperatures and pressures

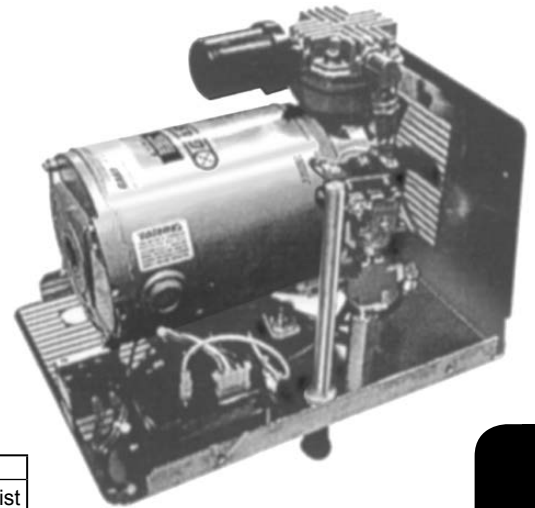

Part Number	Model	List Price Each
992000	CA2000	See separate price list

CHARGE AIR 2000 Specifications

Maximum tank size	20,000 Gallons
Pressure range (adjustable)	40 to 110 PSI
Pressure switch factory setting	45 PSI cut-off
Operating current at 115 volts	6 Amps
Operating current at 208 volts	3.5 Amps
Operating current at 230 volts	3 Amps
Tank connection	2" FPT
Size (LxWxH)	14" x 10" x 17"
Shipping weight	37 Lbs.

How the CHARGE AIR 2000 Works

CHARGE AIR utilizes three primary components: a liquid level switch, a pressure switch, and an air compressor. Through an electrode suspended into the tank from the Charge Air system, the liquid level control continuously monitors the water level of the tank. Simultaneously, the pressure switch monitors the air pressure in the tank. When the water level is above the electrode and the air pressure in the tank drops below its setting, the compressor will start and continue to run until the proper air pressure is reached or the water level drops below the electrode. This constant monitoring guarantees that the optimum air charge is maintained.

Maximum Operating Pressure for Various Tank Sizes

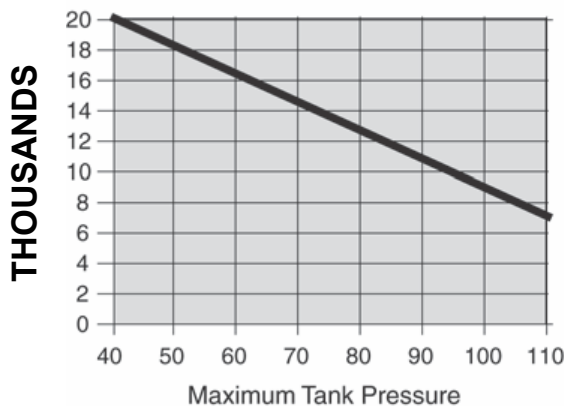

Compressor Output

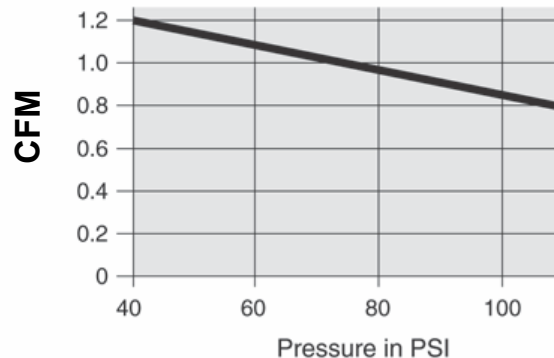

CONSTANT PRESSURE MANIFOLD



CONSTANT PRESSURE MANIFOLD | Patent: D 545, 406

Features:

- Fits 3/4" or 1" male tank fittings
- Lead free ($\leq 0.25\%$ lead content)
- Tapped with (2) 1", (2) 3/4", and (1) 1/4" threads
- Inlet and outlet tapped 1" female x 1-1/4" male

Part Number	Weight (Lbs.)	List Price Each
952280	2.35	See separate price list



CONSTANT PRESSURE MANIFOLD PACKAGES

Consists of:

- (1) 2" Stainless Steel Back Mounted Liquid Filled Gauge 0-100#
Lead free ($\leq 0.25\%$ lead content)
- (1) Spring loaded Pressure Relief Valve, set at 100 PSI at factory
- (1) Steel Mounting Bracket
- (1) 1/2" x 1/4" and (1) 1" x 1/2" Nylon Bushing for transducer connections
- (1) 1" x 3/4" Brass Tank Adapter Bushing
- (1) Chrome Plated Sample Valve or No Lead Brass Hose Bibb

Part Number	Weight (Lbs.)	Optional Connection	List Price Each
952300	5.30	Chrome Plated Sample Valve	See separate price list
952302	5.30	1/4 Turn Brass Hose Bib	

WALL MOUNT BRACKET

Features:

- Steel construction
- Will accept 3/8" bolts for mounting
- Versatile tank discharge center may be positioned 5 3/4" or 8 3/4" from wall
- Includes U bolt and nuts

Part Number	Weight (Lbs.)	List Price Each
952290	1.20	See separate price list



CONSTANT PRESSURE
MANIFOLD

MAASS MIDWEST SOLAR PUMP SYSTEM

Features:

- 3" Submersible Pump
- Rated at 5.2 GPM (Max Flow)
- Rated at 262 ft. of lift (Max TDH)
- Helical Screw Type Impeiler
- 36 VDC Motor Rated at 210 Watts
- Solar Pump Controller
- Electronic Water Level Sensor for the Well
- High Pump Off Level Sensor for Water Trough
- Solar Panel Includes Solar Cable Harness
- Universal Mounting Bracket
- Nema 3R Control Panel Enclosure
- Two Year Warranty

Part Number	Model Number	Weight (Lbs.)	List Price Each
960000	35P-260-36/210 CS	95	See separate price list

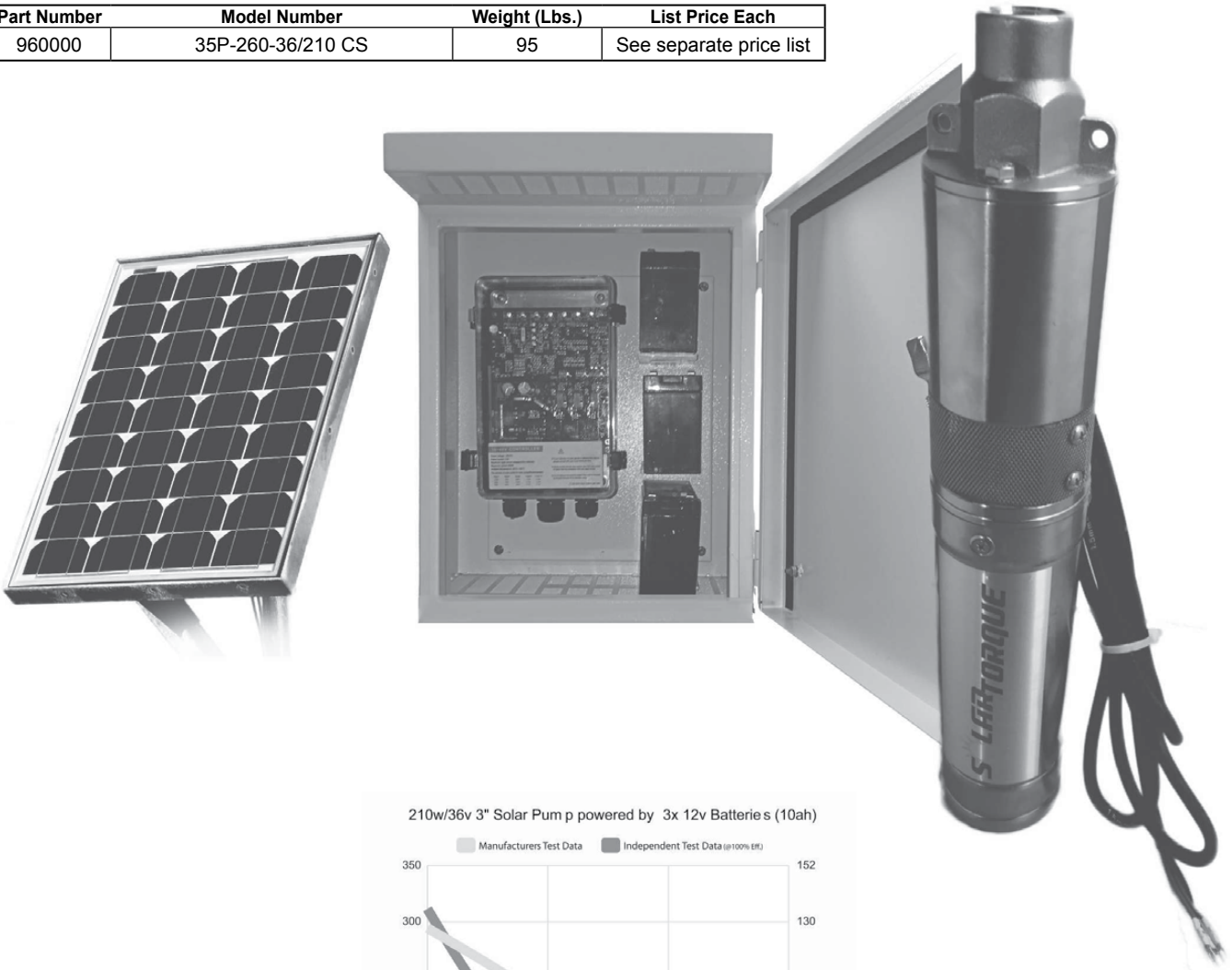

SOLAR PUMP SYSTEM

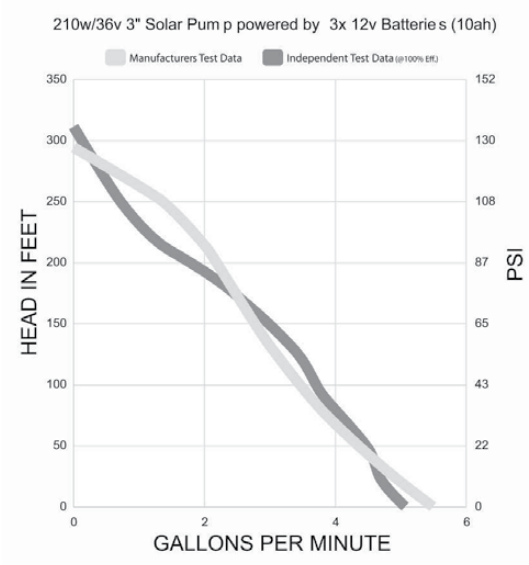

ACCESSORIES

TANK TEES

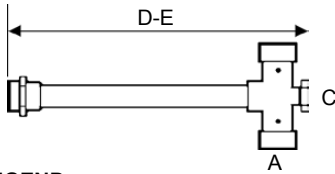

LEGEND:

Letter "D" signifies two (2) drains
 Letter "C" signifies all cast brass tee
 Letter "F" signifies fabricated tee
 Letter "U" signifies fabricated tee with union

Features:

- All tees are fabricated with lead free solder
- 1" tees have 1" male x 3/4" female on inlet and outlet sides of cross
- 1-1/4" tees have 1-1/4" male x 1" female on inlet and outlet sides of cross
- Saves time and easy to install
- Brass and copper construction utilizing tin/silver solder
- Lead Free: ≤ .025% Lead Content

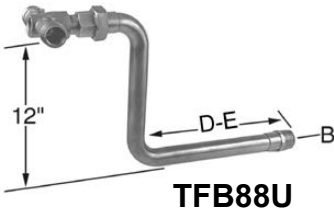

Part Number	Model Number	NPT A O.D. (in.)	NPT A I.D. (in.)	B (in.)	D-E Length (in.)	C Tapping	List Price Each	
Cast Brass								
952270	TCB-1	1	3/4	1 female	2	3/4	See separate price list	
952271	TCB-1D	1	3/4	1 female	2	(2) 1/2		
952273	TCB-2D	1	3/4	1 sweat	2	3/4		
952276	TCB-1S TCB-1SD	1	3/4	1 sweat	2-1/4	(2) 1/2		
952243	TCB-2D	1-1/4	1	1 female X 1-1/4 male	5	(2) 3/4		
952248	TCB-11	1	3/4	1 male	10-3/4	1/2		
952249	TCB-11D	1	3/4	1 male	10-3/4	(2) 1/2		
Fabricated								
952305	TFB-7D	1-1/4	1	1-1/4 male	Flexcon®	(2) 3/4		
952310	TFB-11	1	3/4	1 male	11	3/4		
952313	TFB-11D	1	3/4	1 male	11	(2) 1/2		
952316	TFB-13	1	3/4	1 male	13	3/4		
952319	TFB-13D	1	3/4	1 male	13	(2) 1/2		
952322	TFB-44	1-1/4	1	1-1/4 male	15	3/4		
952325	TFB-44D	1-1/4	1	1-1/4 male	15	(2) 3/4		
With Union								
952340	TFB-13U	1	3/4	1 male	13	3/4		
952344	TFB-13UD	1	3/4	1 male	13	(2) 1/2		
952348	TFB-44U	1-1/4	1	1-1/4 male	16	3/4		
952352	TFB-44UD	1-1/4	1	1-1/4 male	16	(2) 3/4		
952356	TFB-88U	1	3/4	1 male	12	3/4		
952360	TFB-88UD	1	3/4	1 male	12	(2) 1/2		
952364	TFB-88U	1	3/4	1 female	WellMate™	3/4		
952368	TFB-91UF	1	3/4	1 female	WellMate™	(2) 1/2		
952372	TFB-91UFD TFB-99U	1	3/4	1 male	12	3/4		
952376	TFB-99UD	1	3/4	1 male	12	(2) 1/2		
Designed to accommodate the new flush to skirt female tank fittings								
952306	TFB-10	1	3/4	1 male	4 1/2	3/4		
952308	TFB-10D	1	3/4	1 male	4 1/2	(2) 1/2		
952366	TFB-91UMX	1	3/4	1 male	3	3/4		
952370	TFB-91UMDX	1	3/4	1 male	3	(2) 1/2		
952346	TFB-50U	1	3/4	1 male	Flexcon®	3/4		
952347	TFB-50UD	1	3/4	1 male	Flexcon®	(2) 1/2		

ACCESSORIES

GALVANIZED TANK TEE KIT

- Kit includes 1/4" x 3" and 1" x 8" galvanized nipples.

Part Number	Model Number	NPT	B	B-C Length	C Tapping	List Price Each
952260	TFG1-8	1	1 female	11"	1/2	See separate price list

- Kit includes 1/4" x 3" and 1" x 3" galvanized nipples

Part Number	Model Number	NPT	B	B-C Length	C Tapping	List Price Each
952258	TFG1-3X	1	1 female	6"	1/2	See separate price list



TFB99U



TFB91UF

GALVANIZED TANK TEE ONLY

Part Number	Model Number	A NPT	B	C Tapping	List Price Each
952265	TCG-1	1	1 female	1/2	See separate price list
952267	TCG-44	1-1/4	1 1/4 female		



ACCESSORY TOOLS

626 TAPER TAP

- Features:
- Case hardened steel
 - Extra sharp teeth to grab lost pipe or pump
 - Can be used to retrieve well screens

Part Number	Description	Approx. Weight (Lbs.)	List Price Each
930078	Fitted for 1" pipe to pull 3/8" to 1-1/4" pipe	3.5	See separate price list
930081	Fitted for 1-1/4" pipe to pull 3/4" to 2" pipe	6.5	
930084	Fitted for 1-1/2" pipe to pull 2" to 3" pipe	19.0	

626



625 PIPE HOLDER

- Features:
- Cast iron components
 - Will handle 1" thru 2" drop pipe

Part Number	Approx. Weight (Lbs.)	List Price Each
934030	27	See separate price list

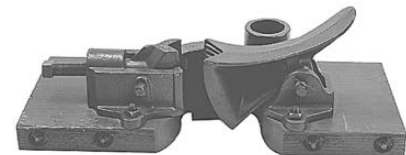

625

629 SAND BUCKETS

- Features:
- Bucket has replaceable check flapper
 - Standard length 4 ft.

Part Number	Well Size (Inches)	Approx. Weight Each (Lbs.)	List Price Each
930090	2	2.0	See separate price list
930099	3	16.0	
930105	4	23.0	



629



MA 100 L



FA-100



HL 100



Combo ELL

CAST RED BRASS

Features:

- Carbide tooling used to machine sharp male barbs
- All U.S. made fitting
- 100% air tested for leaks or defective castings
- XL = Extra long insert
- L = Rope lug
- Lead Free: ≤ .025% Lead Content

MALE ADAPTERS

Part Number	Model Number	IPS X Insert	Quantity per Carton	Weight per Carton (Lbs.)	List Price Each
952220	MA-75	3/4 x 3/4	40	10.0	See separate price list
952222	MA-100	1 x 1	25	10.5	
952224	MA-125	1-1/4 x 1-1/4	15	8.5	
952226	MA-150	1-1/2 x 1-1/2	15	11.5	
952228	MA-75-100	3/4 x 1	32	9.0	
952230	MA-100-125	1 x 1-1/4	20	9.0	
952232	MAXL-100	1 x 1	25	10.5	
952234	MAXL-125	1-1/4 x 1-1/4	15	8.0	
952240	MA-125-100-L	1-1/4 x 1	15	9.0	
952236	MA-100-L	1 x 1	25	12.5	
952238	MA-125-L	1-1/4 x 1-1/4	15	12.0	

FEMALE ADAPTERS

Part Number	Model Number	FIPS X Insert	Quantity per Carton	Weight per Carton (Lbs.)	List Price Each
952202	FA-75	3/4 x 3/4	40	15.5	See separate price list
952204	FA-100	1 x 1	30	15.0	
952206	FA-125	1-1/4 x 1-1/4	15	10.0	
952208	FA-150	1-1/2 x 1-1/2	10	10.0	
952212	FAS-75	3/4 x 3/4	40	15.5	
952210	FAS-75-100	3/4 x 1	40	15.5	
952214	FAS-100	1 x 1	30	15.0	
952216	FAS-125	1-1/4 x 1-1/4	20	10.0	

Note: FAS fittings are sweat x insert

HYDRANT ELLS

- Lead Free: ≤ .025% Lead Content

Part Number	Model Number	MIP X Insert	Quantity per Carton	Weight per Carton (Lbs.)	List Price Each
952192	HL-75	3/4 x 3/4	32	13.5	See separate price list
952196	HL-75-100	3/4 x 1	32	14.0	
952194	HL-100XL	1 x 1	28	15.5	
952205	HL-100TPD	1 x 1	28	15.5	

Note: 952205 HL100TPD - Tapped 1/4" NPT for ground water heat pump sensor or drain

COMBO ELL

Features:

- Female pipe x male adapter
- Ideal in combination with Maass Model J or JC Pitless Adapter
- Extra long male barbs to utilize two hose clamps
- Square body for easy wrenching
- Lead Free: ≤ .025% Lead Content

Part Number	FIPS X Insert	Quantity per Carton	Weight per Carton (Lbs.)	List Price Each
952304	1 x 1	25	25	See separate price list

INSERT FITTINGS

CAST RED BRASS

BRASS WIRE SPUD

Features:

- Bulkhead fitting
- Allows pump wiring to pass through well casing wall
- Ideal for flowing or gaseous well venting
- Lead Free: ≤ .025% Lead Content

Part Number	Model Number	IPS I.D. X IPS O.D.	Quantity per Carton	Weight per Carton (Lbs.)	List Price Each
952184	WS-75-100	3/4 x 1	25	18.5	See separate price list



HYDRANT TEES

- Lead Free: ≤ .025% Lead Content

Part Number	Model Number	Insert X Insert X IPS	Quantity per Carton	Weight per Carton (Lbs.)	List Price Each
952198	HT-75-100	1 x 1 x 3/4	30	18.5	See separate price list
952200	HT-100	1 x 1 x 1	30	19.5	



COUPLINGS

- Lead Free: ≤ .025% Lead Content

Part Number	Model Number	Insert X Insert	Quantity per Carton	Weight per Carton (Lbs.)	List Price Each
952380	C-75	3/4 x 3/4	40	12.0	See separate price list
952382	C-100	1 x 1	25	10.5	
952384	C-125	1-1/4 x 1-1/4	15	9.0	
952386	C-150	1-1/2 x 1-1/2	15	12.0	



ELLS

- Lead Free: ≤ .025% Lead Content

Part Number	Model Number	Insert X Insert	Quantity per Carton	Weight per Carton (Lbs.)	List Price Each
952400	EL-75	3/4 x 3/4	30	10.0	See separate price list
952402	EL-100	1 x 1	25	12.5	
952404	EL-125	1-1/4 x 1-1/4	15	11.5	
952406	EL-150	1-1/2 x 1-1/2	10	10.0	



TEES

- Lead Free: ≤ .025% Lead Content

Part Number	Model Number	Insert X Insert X Insert	Quantity per Carton	Weight per Carton (Lbs.)	List Price Each
952500	TE-75	3/4 x 3/4 x 3/4	30	10.0	See separate price list
952502	TE-100	1 x 1 x 1	25	12.5	
952504	TE-125	1-1/4 x 1-1/4 x 1-1/4	15	11.5	
952506	TE-150	1-1/2 x 1-1/2 x 1-1/2	10	10.0	



UNION

- Lead Free: ≤ .025% Lead Content

Part Number	Model Number	IPS X Insert	Quantity per Carton	Weight per Carton (Lbs.)	List Price Each
952186	U-100	1 x 1	15	11.0	See separate price list
952188	U-125	1-1/4 x 1-1/4	15	16.0	



DICKEN™ INSERT FITTING

INSERT FITTINGS



RED BRASS

- Lead Free: ≤ .025% Lead Content

MALE ADAPTERS

Part Number	Trade Number	Pipe Size (Inches)	Approx. Weight per 100 Pcs.	Pieces per Carton	List Price Each
406604	MAB-2	1/2	15	25	See separate price list
406605	MAB-3	3/4	22	25	
406606	MAB-4	1	35	20	
406607	MAB-5	1-1/4	52	20	
406608	MAB-6	1-1/2	68	20	
406609	MAB-8	2	92	10	
406612	MAB-12	3	250	10	

- Sold by carton quantity only except for MAB 8 & 12

COUPLINGS

Part Number	Trade Number	Pipe Size (Inches)	Approx. Weight per 100 Pcs.	Pieces per Carton	List Price Each
407004	CPB-2	1/2	14	25	See separate price list
407005	CPB-3	3/4	24	25	
407006	CPB-4	1	35	20	
407007	CPB-5	1-1/4	55	20	
407009	CPB-8	2	126	10	

- Sold by carton quantity only except for CPB-8

FEMALE ADAPTERS

Part Number	Trade Number	Pipe Size (Inches)	Approx. Weight per 100 Pcs.	Pieces per Carton	List Price Each
406804	FAB-2	1/2	20	25	See separate price list
406805	FAB-3	3/4	25	25	
406806	FAB-4	1	35	20	
406807	FAB-5	1-1/4	55	20	
406808	FAB-6	1-1/2	70	10	

- Sold by carton quantity only

GALVANIZED STEEL

- Lead Free: ≤ .025% Lead Content

MALE ADAPTERS

Part Number	Trade Number	Pipe Size (Inches)	Approx. Weight per 100 (Lbs.)	Pieces per Carton	List Price Each
406504	MAS-2	1/2	15	25	See separate price list
406505	MAS-3	3/4	22	25	
406506	MAS-4	1	35	20	
406507	MAS-5	1-1/4	52	20	
406508	MAS-6	1-1/2	68	20	
406509	MAS-8	2	92	10	
406510	MAS-10	2-1/2	200	10	
406511	MAS-12	3	250	10	
406513	MAS-16	4	450	10	

- Sold by carton only except for MAS 12 & 16

COUPLINGS

Part Number	Trade Number	Pipe Size (Inches)	Approx. Weight per 100 Pcs.	Pieces per Carton	List Price Each
406904	CPS-2	1/2	14	25	See separate price list
406905	CPS-3	3/4	24	25	
406906	CPS-4	1	35	20	
406907	CPS-5	1-1/4	55	20	
406908	CPS-6	1-1/2	66	20	
406909	CPS-8	2	126	10	

- Sold by carton only

FEMALE ADAPTERS

Part Number	Trade Number	Pipe Size (Inches)	Approx. Weight per 100 Pcs.	Pieces per Carton	List Price Each
406704	FAS-2	1/2	20	10	See separate price list
406705	FAS-3	3/4	25	25	
406706	FAS-4	1	35	20	
406707	FAS-5	1-1/4	65	20	

- Sold by carton only

INSERT FITTINGS

GALVANIZED STEEL INSERT FITTINGS

VENTURI MALE ADAPTERS

Part Number	Trade Number	Pipe Size (Inches)	Length (Inches)	Pieces per Carton	Approx. Weight per 100 Pcs.	List Price Each
408005	VMAS-3	3/4	12	5	120	See separate price list
407706	VMAS-4	1	6	5	78	
407806	VMAS-4	1	8	5	104	
407707	VMAS-5	1-1/4	6	5	102	

• Sold by carton only

PLASTIC INSERT FITTINGS

POLY PLUS

Part Number	Size (Inches)	Pieces per Box	Approx. Weight per Box (Lbs.)	Pieces per Carton	List Price Each
Adapters - Plastic to Male					
514004	1/2	25	0.5	600	See separate price list
514005	3/4	25	0.8	350	
514006	1	25	1.3	200	
514007	1-1/4	10	2.3	200	
514008	1-1/2	10	1.2	80	
514010	2	5	1.7	80	
Couplings - Plastic to Plastic					
518004	1/2	25	0.8	600	
518005	3/4	25	1.0	350	
518006	1	25	1.2	350	
518007	1-1/4	10	1.4	200	
518008	1-1/2	10	1.7	240	
518010	2	5	2.0	80	
Elbows - PL x PL					
521004	1/2	10	1.4	600	
521005	3/4	10	1.7	350	
521006	1	10	1.9	200	
521007	1-1/4	10	1.0	140	
521008	1-1/2	10	1.5	80	
521010	2	5	1.2	40	
Tees - PL x PL x PL					
539004	1/2	10	1.7	200	
539005	3/4	10	1.9	200	
539006	1	5	1.3	80	
539007	1-1/4	5	2.1	80	
539008	1-1/2	5	1.4	40	
539010	2	3	1.2	24	

NYLON

Part Number	Size (Inches)	Pieces per Box	Approx. Weight per Box (Lbs.)	Pieces per Carton	List Price Each
Adapters - Plastic to Male					
515004	1/2	25	0.6	600	See separate price list
515005	3/4	25	0.9	350	
515006	1	25	1.8	200	
515007	1-1/4	10	2.7	200	
515008	1-1/2	10	1.6	80	
515010	2	5	2.0	80	
Couplings - Plastic to Plastic					
519004	1/2	25	1.0	600	
519005	3/4	25	1.2	350	
519006	1	25	1.4	350	
519007	1-1/4	10	1.6	200	
519008	1-1/2	10	2.0	240	
519010	2	10	2.4	80	
Elbows - PL x PL					
522004	1/2	10	1.7	600	
522005	3/4	10	1.9	350	
522006	1	10	2.5	200	
522007	1-1/4	10	1.2	140	
522008	1-1/2	10	1.9	80	
522010	2	5	1.5	40	
Tees - PL x PL x PL					
540004	1/2	10	1.9	200	
540005	3/4	10	2.7	200	
540006	1	5	1.8	80	
540007	1-1/4	5	2.6	80	
540008	1-1/2	5	1.8	40	
540010	2	3	2.1	24	
Bushings					
532110	1/2 x 1/4	25	.50	100	
532100	1 x 1/2	25	.75	100	
532105	1-1/4 x 1	25	1.1	100	
532125	1-1/2 x 1-1/4	25	1.38	100	
532135	2 x 1-1/4	25	1.82	100	
532140	2 x 1-1/2	25	1.63	100	

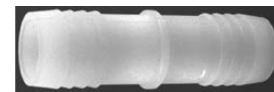
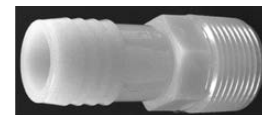

INSERT FITTINGS

SERVICE VALVES

GATE VALVES

Features:

- Cast red brass, 125 PSI, non-rising stem



Part Number	Valve Size (Inches)	Pieces per Box	Pieces per Carton	Approx. Weight per Carton (Lbs.)	List Price Each
961003	1/2 IPS	10	120	72	See separate price list
961004	3/4 IPS	10	90	76	
961005	1 IPS	5	60	73	
961006	1-1/4 IPS	5	40	74	
961007	1-1/2 IPS	4	32	79	
961008	2 IPS	2	20	68	
961009	2-1/2 IPS	1	12	70	
961010	3 IPS	1	8	66	
961011	4 IPS	1	6	46	

BALL VALVES

Features:

- Cast red brass body rated 200 WOG, 150 SWP
- Full port flow



Part Number	Valve Size (Inches)	Pieces per Box	Pieces per Carton	Approx. Weight per Carton (Lbs.)	List Price Each
961033	1/2	10	120	44	See separate price list
961034	3/4	10	90	48	
961035	1	6	60	57	
961036	1-1/4	1	36	65	
961037	1-1/2	1	24	53	
961038	2	1	16	51	

BOILER DRAIN

Features:

- Cast red brass body and brass stem



Part Number	IPS Valve Size (Inches)	Thread	Pieces per Box	Pieces per Carton	Approx. Weight per Carton (Lbs.)	List Price Each
961071	1/2	Male	12	144	70	See separate price list
961072	3/4	Male	12	144	75	

1/4 TURN HOSE BIBB

Features:

- Cast redbrass body
- Lead free ($\leq 0.025\%$ lead content)



Part Number	Valve Size (Inches)	Pieces per Box	Pieces per Carton	Approx. Weight per Carton (Lbs.)	List Price Each
961126	1/2	12	144	69	See separate price list
961128	3/4	12	144	76	

CHROME PLATED SAMPLE VALVE

Features:

- Chrome plated to minimize contamination of sample
- Standard size to easily install in tank T head
- Meets Wisconsin state code



Part Number	Thread Size	List Price Each
961133	1/2"	See separate price list
961134	3/4"	

VACUUM BREAKER

Features:

- Brass construction backflow preventer
- Meets codes where necessary
- Break off attachment screw for permanent installation
- Fits hose bibs and boiler drains



Part Number	Valve Size (Inches)	Pieces per Box	Pieces per Carton	Approx. Weight per Carton (Lbs.)	List Price Each
961150	3/4	6	72	18	See separate price list

- Note: Lead Free: $\leq .025\%$ Lead Content

PACKERS/SEALS



TRI-SEAL/K-PACKER

Features:

- Provides seal between outside diameter of the screen and inside diameter of well casing
- Manufactured by moulding rubber to outside diameter of a threaded steel coupling

Part Number	Casing Size	Connection Size	Weight (Lbs.)	List Price Each
917202	2	1-1/4	1.3	See separate price list
917204	3	1-1/4	1.3	
917206	3	2	1.7	
917208	4	1-1/4	1.02	
917210	4	2	1.02	
917212	4	2-1/2	2.25	
917214	4	3	1.50	
917216	4-1/8	3	1.50	
917218	4-1/2	2	1.25	
917220	4-1/2	3	1.50	
917222	5	2	1.25	
917224	5	3	2.50	
917226	5	4	2.50	
917228	5-3/4	4	3.00	
917230	6	3	3.75	
917232	6	4	3.00	
917234	6	5	3.00	
917236	6-1/4	4	3.20	
917238	6-1/4	5	3.10	
917240	8	6	7.25	



SHALE TRAP/FORMATION PACKER

Features:

- Provides collection point seal for material to pack off top of well casing
- Unique rubber design seals against drill hole as lower portion firmly clamps to well casing
- All stainless steel clamp provided

Part Number	Hole Size	Casing Size	Weight (Lbs.)	List Price Each
917002	5	2	.50	See separate price list
917004	6	2	.50	
917006	6	3	.80	
917008	7	4	.80	
917010	8	4	.80	
917012	8	4-1/2	.80	
917014	8	5	1.1	
917016	9	5	1.6	
917018	10	6	1.4	
917020	10	6.9	1.4	



DRAW-DOWN SEALS

Features:

- Prevents contamination and air from entering pump
- Stabilizes and centers pump and riser
- Used to seal eroding wells
- Holes for pump wires and wire sealing plugs provided

Part Number	Hole Size	Drop Pipe Size	Weight (Lbs.)	List Price Each
935700	4	1	.8	See separate price list
935702	4	1-1/4	1.0	
935704	4	1-1/2	1.0	
935706	5	1	1.2	
935708	5	1-1/4	1.2	
935710	5	1-1/2	2.0	
935712	5	2	2.2	
935714	8	3	3.7	



COUPLINGS



434

GALVANIZED TURNED COUPLINGS

Part Number	Pipe Size (Inches)	O.D. (Inches)	Length (Inches)	Approx. Weight (Lbs.)	Thread Design	List Price Each
941532	1-1/4	1-5/8	2-1/4	.5	Standard	See separate price list
941548	1-1/4	434J 1-13/16	2-1/4	.5	Straight	



623

TOOL COUPLINGS

Features:

- Couplings made of seamless steel tubing, extra long and heavy
- Specially made for use with well tools and drill rods.(Black only)
- Threaded for standard pipe

Part Number	Pipe Size (Inches)	O.D. (Inches)	Length (Inches)	Approx. Weight (Lbs.)	Thread Design	List Price Each
941555	1	1-5/8	3-1/2	1	Straight	See separate price list
941567	1	1-5/8	3-1/2	1	Tapered	

COMPRESSION COUPLINGS - 78

Features:

- Plastic PVC construction



78 PVC

Part Number	IPS Size (Inches)	Length (Inches)	Pieces per Carton	Carton Weight (Lbs.)	List Price Each
941625	1/2	4	25	7.1	See separate price list
941626	3/4	4-1/4	15	5.0	
941627	1	4-1/2	15	7.5	
941628	1-1/4	5	10	6.8	
941629	1-1/2	5-1/2	10	8.6	
941630	2	6	10	11.7	

SLIP COUPLINGS - 781

Features:

- Galvanized steel construction



781

Part Number	Pipe Size (Inches)	Approx. Weight Each (Lbs.)	List Price Each
941580	1/2	0.75	See separate price list
941581	3/4	1.0	
941582	1	1.25	
941583	1-1/4	1.5	
941584	1-1/2	2.0	
941585	2	2.5	

STANDARD MERCHANT COUPLINGS

Part Number	Nominal Size/Type	Pipe Size O.D.	Coupling O.D.	Length	Threads per Inch	Pieces per Carton	List Price Each
100404	1/2 Galv.	.840	1.063	1-9/16	14	100	See separate price list
100405	3/4 Galv.	1.050	1.313	1-5/8	14	50	
100406	1 Galv.	1.315	1.576	2	11-1/2	30	
100409	1-1/4 Galv.	1.660	1.900	2-1/16	11-1/2	25	
100413	1-1/2 Galv.	1.900	2.200	2-1/16	11-1/2	25	
100422	2 Galv.	2.375	2.750	2-1/8	11-1/2	20	

WATER WELL REAMED & DRIFTED COUPLINGS

Part Number	Nominal Size/Type	Pipe Size O.D.	Coupling O.D.	Length	Threads per Inch	Pieces per Carton	List Price Each
117109	1-1/4 Galv.	1.660	1.900	2-3/4	11-1/2	25	See separate price list
117122	2 Galv.	2.375	2.750	3-3/8	11-1/2	15	

REAMED AND DRIFTED COUPLINGS

Part Number	Size (Thread X Thread)	List Price Each
100440	3"	See separate price list
100449	4"	
100458	5"	
100467	6"	
100476	8"	

• Note: Lead Free: ≤ .025% Lead Content

COUPLINGS

STAINLESS STEEL DROP PIPE COUPLING

Features:

- Heavy cast 3004 stainless steel
- Threads tapered from both ends
- Flats for easy wrenching

Part Number	Pipe Size (Inches)	Overall Length (Inches)	Approx. Weight	List Price Each
932086	1	2-1/2	.40	See separate price list
932087	1-1/4	2-1/2	.60	
932088	1-1/2	2-1/2	.75	
932089	2	2-3/4	1.50	



PVC DROP PIPE COUPLING

Features:

- Manufactured from special PVC coupling stock
- 25% greater tensile strength than schedule 80 PVC pipe
- Stronger than schedule 120 couplings

Part Number	Pipe Size (Inches)	Overall Length (Inches)	Standard Pkg. Qty.	Approx. Weight per 100 (Lbs.)	List Price Each
932096	1	2-3/4	20	19	See separate price list
932097	1-1/4	2-3/4	20	24	
932098	1-1/2	2-3/4	15	25	
932099	2	3	10	34	

Note: • To be used in well depths no greater than 400', as installed according to instructions.
• Sold in package quantities only.



11P

STRAUB GRIP L COUPLINGS

Features:

- Joins all kinds of metal pipe
- Saves time — no welding, flanging or threading required
- Use with all types of piping materials
- EPDM rubber sealing sleeve for all qualities of water, waste water, air, solids and chemical products
- 304 stainless steel case

Part Number	IPS Size (Inches)	Overall Length (Inches)	Torque Rate Ft. lbs./Nm	Working Pressure	Approx. Weight per 100 (Lbs.)	List Price Each
941608	2	3	11/15	320/22	1.2/0.5	See separate price list
941610	2-1/2	3-3/4	15/20	450/31	2.7/1.2	
941612	3	3-3/4	15/20	450/31	2.6/1.2	
941614	4	3-3/4	18/25	232/16	3.2/1.5	
941615	5	3-3/4	30/40	232/16	5.7/2.6	
941616	6	4-3/8	30/40	232/16	6.4/2.9	
941617	8	5-1/2	45/60	232/16	13.0/5.9	
941618	10	5-1/2	37/50	100/7	12.7/5.8	



JX1 SERIES FULL WELD COUPLING

Features:

- Used with JX1 Pitless threaded unit to steel casing
- Weld X female NPT thread

Part Number	Model Number	List Price Each
929100	4" FWC	See separate price list
929200	5" FWC	
929300	6" FWC	
929400	8" FWC	
929450	10" FWC	



WELD-ON COUPLINGS

Part Number	Size (Weld X Weld)	List Price Each
941500	4"	See separate price list
941505	5"	
941510	6"	



COUPLINGS



541 PITLESS CONNECTOR

Features:

- Slip type compression coupling for threading on male end of pitless adapter
- Rubber compression end slips over well pipe
- Offers watertight, secure connection

Part Number	Description	List Price Each
932043	5" female NPT X 4" compression	See separate price list



STANDPIPE ADAPTER COUPLING

Features:

- Allows use of standard pitless adapter with 4" casing
- Easy to install
- Durable, watertight construction
- For upgrading 4" wells

Part Number	Model	I.D. Casing Size (In.)	O.D. Casing Size (In.)	Ring I.D. (Inches)	Shipping Weight (Lbs.)	List Price Each
952190	SA-4-5	5 Top 4 Bottom	5-9/16 4-1/2	5-11/16 4-11/16	17	See separate price list

PVC COUPLINGS, SPIGOTS AND ADAPTERS

Features:

- Meets ASTM F-480 standards for tapered socket or bell end pipe



Part Number	Model Number	Description	List Price Each
941802	COUP44L	4 X 4 Long Coupling	See separate price list
941804	COUP44LTRND	4 X 4 Coupling Turned	
941806	COUP54R	5 X 4 Red Coup Bell X Bell	
941808	COUP54SP	5 X 4 Spigot Coupling	
941810	COUP54SPWTHD	5 X 4 Spigot with 4" NPTTHD	
941812	COUP55L	5 X 5 Long Coupling	
941814	COUP65	6 X 5 PVC Coupling	
941818	COUP65SP	6 X 5 Spigot Coupling	
941820	COUP66L	6 X 6 Bell X Bell Long Coupling	
941822	COUP6.255WTHD	6-1/4 X 5 Male NPT Coupling	
941824	COUP6.25R	6-1/4 Bell X 6 Bell Red Coupling	
941826	COUP6.25RWTHD	6-1/4 Bell X Bell Long Coupling	
941828	COUP45.L	4-1/2 X 1-1/4 Long Coupling	

ROUGH BRASS THREADED FITTINGS

ROUGH BRASS THREADED FITTINGS

Features:

- 125 lbs. Steam
- 175 lbs. WOG
- Red Brass
- Lead Free: ≤ .025% Lead Content



Part Number	Description	Quantity per Box	Weight per Box (Lbs.)	List Price Each
551002	1/4 45° Ell	25	2.0	See separate price list
551003	3/8 45° Ell	25	3.3	
551004	1/2 45° Ell	25	5.0	
551005	3/4 45° Ell	25	7.0	
551006	1 45° Ell	25	12.8	
551007	1-1/4 45° Ell	10	7.5	
551008	1-1/2 45° Ell	10	9.5	
551010	2 45° Ell	5	8.7	



Part Number	Description	Quantity per Box	Weight per Box (Lbs.)	List Price Each
552002	1/4 90° Ell	25	2.5	See separate price list
552003	3/8 90° Ell	25	3.3	
552004	1/2 90° Ell	25	5.0	
552005	3/4 90° Ell	25	8.0	
552006	1 90° Ell	25	5.8	
552007	1-1/4 90° Ell	10	9.1	
552008	1-1/2 90° Ell	5	5.75	
552010	2 90° Ell	5	9.75	
552074	3/4 x 1/2 90° Ell	25	8.0	
552089	1 x 3/4 90° Ell	25	10.25	
552104	1-1/4 x 1 90° Ell	10	8.0	
552120	1-1/2 x 1-1/4 90° Ell	5	5.0	

COUPLINGS/ROUGH BRASS THREADED FITTINGS

ROUGH BRASS THREADED FITTINGS

ROUGH BRASS THREADED FITTINGS

Features:

- 125 lbs. Steam
- 175 lbs. WOG
- Red Brass
- Lead Free: ≤ .025% Lead Content

Part Number	Description	Quantity per Box	Weight per Box (Lbs.)	List Price Each
553002	1/4 90° St Ell	25	2.15	See separate price list
553003	3/8 90° St Ell	25	3.75	
553004	1/2 90° St Ell	25	4.0	
553005	3/4 90° St Ell	25	9.0	
553006	1 90° St Ell	10	5.6	
553007	1-1/4 90° St Ell	10	8.6	
553008	1-1/2 90° St Ell	10	11.50	
553010	2 90° St Ell	5	8.25	



Part Number	Description	Quantity per Box	Weight per Box (Lbs.)	List Price Each
562002	1/4 45° St Ell	25	1.8	See separate price list
562004	1/2 45° St Ell	25	5.0	
562005	3/4 45° St Ell	25	7.0	
562006	1 45° St Ell	10	4.4	
562007	1-1/4 45° St Ell	5	3.4	
562010	2 45° St Ell	Bulk	1.4	



Part Number	Description	Quantity per Box	Weight per Box (Lbs.)	List Price Each
554002	1/4 Tee	25	3.0	See separate price list
554003	3/8 Tee	25	5.3	
554004	1/2 Tee	25	7.5	
554005	3/4 Tee	25	12.0	
554006	1 Tee	10	8.0	
554007	1-1/4 Tee	5	5.8	
554008	1-1/2 Tee	5	7.9	
554010	2 Tee	3	6.6	



Part Number	Description	Quantity per Box	Weight per Box (Lbs.)	List Price Each
554273	3/4 x 1/2 x 1/2 Tee	25	3.5	See separate price list
554274	3/4 x 1/2 x 3/4 Tee	10	4.0	
554281	3/4 x 3/4 x 1/2 Tee	10	4.3	
554304	1 x 1/2 x 1 Tee	10	6.0	
554308	1 x 3/4 x 3/4 Tee	10	5.5	
554309	1 x 3/4 x 1 Tee	10	6.5	
554315	1 x 1 x 1/2 Tee	10	6.0	
554316	1 x 1 x 3/4 Tee	10	7.0	
554366	1-1/4 x 1-1/4 x 1 Tee	5	5.0	
554365	1-1/4 x 1-1/4 x 3/4 Tee	10	8.5	
554401	1-1/2 x 1 x 1 Tee	5	5.5	
554423	1-1/2 x 1-1/2 x 1 Tee	5	6.5	
554476	2 x 2 x 3/4 Tee	5	8.0	
554477	2 x 2 x 1 Tee	Bulk	1.8	



Part Number	Description	Quantity per Box	Weight per Box (Lbs.)	List Price Each
550001	1/8 Coupling	25	1.0	See separate price list
550002	1/4 Coupling	25	2.3	
550003	3/8 Coupling	25	3.0	
550004	1/2 Coupling	25	6.2	
550005	3/4 Coupling	25	7.0	
550006	1 Coupling	25	10.8	
550007	1-1/4 Coupling	10	6.2	
550008	1-1/2 Coupling	10	8.0	
550010	2 Coupling	5	6.2	



Part Number	Description	Quantity per Box	Weight per Box (Lbs.)	List Price Each
550041	1/4 x 1/8 Reducer Coupling	25	2.0	See separate price list
550061	1/2 x 1/4 Reducer Coupling	25	3.7	
550072	3/4 x 1/4 Reducer Coupling	25	5.0	
550074	3/4 x 1/2 Reducer Coupling	25	6.0	
550088	1 x 1/2 Reducer Coupling	25	8.0	
550089	1 x 3/4 Reducer Coupling	25	8.5	
550105	1-1/4 x 1 Reducer Coupling	10	6.0	
550118	1-1/2 x 3/4 Reducer Coupling	10	6.5	
550119	1-1/2 x 1 Reducer Coupling	10	6.0	
550120	1-1/2 x 1-1/4 Reducer Coupling	10	7.4	
550132	2 x 3/4 Reducer Coupling	10	8.5	
550133	2 x 1 Reducer Coupling	10	10.0	
550134	2 x 1-1/4 Reducer Coupling	10	10.5	
550135	2 x 1-1/2 Reducer Coupling	5	5.2	



ROUGH BRASS THREADED FITTINGS

ROUGH BRASS THREADED FITTINGS

ROUGH BRASS THREADED FITTINGS

Features:

- 125 lbs. Steam
- 175 lbs. WOG
- Red Brass
- Lead Free: ≤ .025% Lead Content



Part Number	Description	Quantity per Box	Weight per Box (Lbs.)	List Price Each
560001	1/8 Solid	25	0.3	See separate price list
560002	1/4 Solid	25	0.8	
560003	3/8 Solid	25	1.3	
555004	1/2 Plug	25	2.5	
555005	3/4 Plug	25	3.0	
555006	1 Plug	25	5.8	
555007	1-1/4 Plug	25	9.8	
555008	1-1/2 Plug	25	10.3	
555010	2 Plug	10	6.4	



Part Number	Description	Quantity per Box	Weight per Box (Lbs.)	List Price Each
556001	1/8 Cap	25	1.0	See separate price list
556002	1/4 Cap	25	1.2	
556004	1/2 Cap	25	3.0	
556005	3/4 Cap	25	4.3	
556006	1 Cap	25	7.3	
556007	1-1/4 Cap	25	11.2	
556010	2 Cap	10	11.0	



Part Number	Description	Quantity per Box	Weight per Box (Lbs.)	List Price Each
557041	1/4 x 1/8 Hex Bushing	25	0.5	See separate price list
557049	3/8 x 1/4 Hex Bushing	25	1.0	
557060	1/2 x 1/8 Hex Bushing	25	2.5	
557061	1/2 x 1/4 Hex Bushing	25	2.3	
557062	1/2 x 3/8 Hex Bushing	25	1.5	
557072	3/4 x 1/4 Hex Bushing	25	3.8	
557073	3/4 x 3/8 Hex Bushing	25	5.0	
557074	3/4 x 1/2 Hex Bushing	25	2.5	
557086	1 x 1/4 Hex Bushing	25	5.5	
557087	1 x 3/8 Hex Bushing	25	5.5	
557088	1 x 1/2 Hex Bushing	25	5.5	
557089	1 x 3/4 Hex Bushing	25	5.0	
557103	1-1/4 x 1/2 Hex Bushing	25	10.0	
557104	1-1/4 x 3/4 Hex Bushing	25	9.5	
557105	1-1/4 x 1 Hex Bushing	25	7.8	
557118	1-1/2 x 3/4 Hex Bushing	25	12.5	
557119	1 1/2 x 1 Hex Bushing	25	12.8	
557120	1-1/2 x 1-1/4 Hex Bushing	25	9.3	
557131	2 x 1/2 Hex Bushing	10	10.0	
557132	2 x 3/4 Hex Bushing	10	9.5	
557133	2 x 1 Hex Bushing	10	9.0	
557134	2 x 1-1/4 Hex Bushing	10	7.5	
557135	2 x 1-1/2 Hex Bushing	10	6.5	



Part Number	Description	Quantity per Box	Weight per Box (Lbs.)	List Price Each
558002	1/4 Union	25	3.7	See separate price list
558004	1/2 Union	25	8.7	
558005	3/4 Union	25	12.5	
558006	1 Union	10	7.5	
558007	1-1/4 Union	5	7.0	
558008	1-1/2 Union	5	7.8	
558010	2 Union	Bulk	2.2	

ROUGH BRASS
THREADED FITTINGS

RED BRASS NIPPLES

Features:

- Lead Free: ≤ .025% Lead Content

Part Number	Description	Quantity per Box	Weight per Box (Lbs.)	List Price Each	
270051	1/4 x Close	25	0.5		
270052	1/4 x 1-1/2	25	1.2		
270053	1/4 x 2	25	1.5		
270054	1/4 x 2-1/2	25	2.0		
270055	1/4 x 3	25	2.5		
270056	1/4 x 3-1/2	25	3.0		
270057	1/4 x 4	25	3.3		
270058	1/4 x 4-1/2	25	4.0		
270059	1/4 x 5	25	4.3		
270060	1/4 x 5-1/2	25	5.0		
270061	1/4 x 6	25	5.0		
270126	3/8 x Close	25	1.0		
270128	3/8 x 2	25	2.0		
270130	3/8 x 3	25	3.3		
270132	3/8 x 4	25	4.5		
270134	3/8 x 5	25	5.5		
270136	3/8 x 6	25	6.8		
270201	1/2 x Close	25	1.3		
270202	1/2 x 1-1/2	25	2.1		
270203	1/2 x 2	25	2.8		
270204	1/2 x 2-1/2	25	4.0		
270205	1/2 x 3	25	4.5		
270206	1/2 x 3 1/2	25	5.6		
270207	1/2 x 4	25	6.3		
270208	1/2 x 4-1/2	25	7.4		
270209	1/2 x 5	25	8.0		
270210	1/2 x 5-1/2	25	9.3		
270211	1/2 x 6	25	10.0		
270301	3/4 x Close	25	2.3		
270302	3/4 x 1-1/2	25	2.9		
270303	3/4 x 2	25	4.0		
270304	3/4 x 2-1/2	25	5.4		
270305	3/4 x 3	25	5.6		
270306	3/4 x 3-1/2	25	7.7		
270307	3/4 x 4	25	8.9		
270308	3/4 x 4-1/2	25	9.8		
270309	3/4 x 5	25	11.0		
270310	3/4 x 5-1/2	25	12.0		
270311	3/4 x 6	25	13.3		
270401	1 x Close	25	3.9	See separate price list	
270402	1 x 2	25	5.8		
270403	1 x 2-1/2	25	7.4		
270404	1 x 3	25	9.2		
270405	1 x 3-1/2	25	10.8		
270406	1 x 4	25	12.5		
270407	1 x 4-1/2	25	14.3		
270408	1 x 5	25	16.3		
270410	1 x 6	25	19.8		
270501	1-1/4 x Close	10	2.4		
270502	1-1/4 x 2	10	3.6		
270503	1-1/4 x 2-1/2	10	4.5		
270504	1-1/4 x 3	10	5.6		
270505	1-1/4 x 3-1/2	10	6.8		
270506	1-1/4 x 4	10	8.1		
270507	1-1/4 x 4-1/2	10	9.2		
270508	1-1/4 x 5	10	9.8		
270509	1-1/4 x 5 1/2	10	11.0		
270510	1-1/4 x 6	10	12.5		
270551	1-1/2 x Close	10	3.5		
270552	1-1/2 x 2	10	4.2		
270553	1-1/2 x 2-1/2	10	5.5		
270554	1-1/2 x 3	10	6.7		
270555	1-1/2 x 3-1/2	10	8.1		
270556	1-1/2 x 4	10	9.5		
270557	1-1/2 x 4-1/2	10	10.8		
270558	1-1/2 x 5	10	12.1		
270559	1-1/2 x 5-1/2	10	13.1		
270560	1-1/2 x 6	10	14.4		
270601	2 x Close	10	5.4		
270602	2 x 2-1/2	10	7.2		
270603	2 x 3	10	8.8		
270604	2 x 3-1/2	10	10.7		
270605	2 x 4	10	12.5		
270606	2 x 4-1/2	10	14.3		
270607	2 x 5	10	15.5		
270608	2 x 5-1/2	10	17.9		
270609	2 x 6	10	19.0		
270617	2 x 10	10	31.0		
270621	2 x 12	10	38.0		

Note: Other sizes available upon request

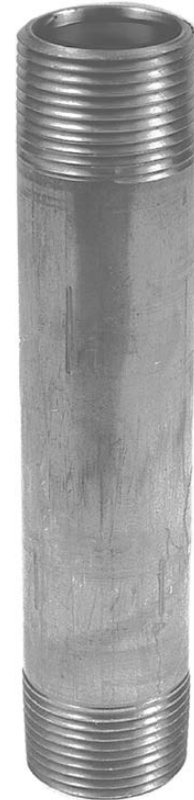

RED BRASS NIPPLES

PVC NIPPLES

PVC NIPPLES
DRIVE SHOES



Features:

- Schedule 40
- Lead Free: ≤ .025% Lead Content

Part Number	Size (Inches) I.D. X Length	Weight Each	List Price Each
284312-PE	3" X 12" S40 NIPPLE NPT x PE	1.6	See separate price list
284312-NPT	3" X 12" S40 NIPPLE NPT x NPT	1.6	
284312-Plg	3" X 12" S40 NIPPLE NPT x Plug	1.6	
284318-PE	3" X 18" S40 NIPPLE NPT x PE	2.5	
284318-NPT	3" X 18" S40 NIPPLE NPT x NPT	2.5	
284318-Plg	3" X 18" S40 NIPPLE NPT x Plug	2.5	
284324-PE	3" X 24" S40 NIPPLE NPT x PE	3.3	
284324-NPT	3" X 24" S40 NIPPLE NPT x NPT	3.3	
284324-Plg	3" X 24" S40 NIPPLE NPT x Plug	3.3	
284412-PE	4" X 12" S40 NIPPLE NPT x PE	2.4	
284412-NPT	4" X 12" S40 NIPPLE NPT x NPT	2.4	
284412-Plg	4" X 12" S40 NIPPLE NPT x Plug	2.4	
284418-PE	4" X 18" S40 NIPPLE NPT x PE	3.5	
284418-NPT	4" X 18" S40 NIPPLE NPT x NPT	3.5	
284418-Plg	4" X 18" S40 NIPPLE NPT x Plug	3.5	
284424-PE	4" X 24" S40 NIPPLE NPT x PE	4.7	
284424-NPT	4" X 24" S40 NIPPLE NPT x NPT	4.7	
284424-Plg	4" X 24" S40 NIPPLE NPT x Plug	4.7	

Features:

- Schedule 80
- Lead Free: ≤ .025% Lead Content

Part Number	Size (Inches) I.D. X Length	Weight Each	List Price Each
288312-PE	3" X 12" S80 NIPPLE NPT x PE	2.2	See separate price list
288312-NPT	3" X 12" S80 NIPPLE NPT x NPT	2.2	
288312-Plg	3" X 12" S80 NIPPLE NPT x Plug	2.2	
288318-PE	3" X 18" S80 NIPPLE NPT x PE	3.4	
288318-NPT	3" X 18" S80 NIPPLE NPT x NPT	3.4	
288318-Plg	3" X 18" S80 NIPPLE NPT x Plug	3.4	
288324-PE	3" X 24" S80 NIPPLE NPT x PE	4.5	
288324-NPT	3" X 24" S80 NIPPLE NPT x NPT	4.5	
288324-Plg	3" X 24" S80 NIPPLE NPT x Plug	4.5	
288412-PE	4" X 12" S80 NIPPLE NPT x PE	3.3	
288412-NPT	4" X 12" S80 NIPPLE NPT x NPT	3.3	
288412-Plg	4" X 12" S80 NIPPLE NPT x Plug	3.3	
288418-PE	4" X 18" S80 NIPPLE NPT x PE	4.9	
288418-NPT	4" X 18" S80 NIPPLE NPT x NPT	4.9	
288418-Plg	4" X 18" S80 NIPPLE NPT x Plug	4.9	
288424-PE	4" X 24" S80 NIPPLE NPT x PE	6.5	
288424-NPT	4" X 24" S80 NIPPLE NPT x NPT	6.5	
288424-Plg	4" X 24" S80 NIPPLE NPT x Plug	6.5	

DRIVE SHOES

421 DRIVE SHOES

Features:

- 1/2 of shoe heat treated to 48-54 Rockwell "C" - hardness tested
- Highest quality seamless steel tube (to A.P.I. specs)
- Concentric machining assures straight setting in well
- Inside bevel on cable styled shoes radiused to allow drilling tools to be easily pulled back through shoe
- Zinc phosphate coated and painted to enhance appearance and corrosion-resistance
- Lead Free: ≤ .025% Lead Content



Cable Tool Style - Threaded - Model 421T

Part Number	Casing Nominal	Casing O.D.	Shoe O.D.	Shoe I.D.	Shoe Length	Thread Type	List Price Each
941274	2	2-3/8	2.875	2-3/32	3	11-1/2 NPS	See separate price list
941285	4	4-1/2	5.000	4-1/16	4	8 NPS	
941287	5	5-9/16	6.050	5-3/16	4-1/2	8 NPS	
941289	6	6-5/8	7.390	6-5/32	5-1/2	8 NPS	

Cable Tool Style - Weld On - Model 421W

Part Number	Casing Nominal	Casing O.D.	Shoe O.D.	Shoe I.D.	Shoe Length	Thread Type	List Price Each
941318	4	4-1/2	5.000	4-1/16	4	-	See separate price list
941320	5	5-9/16	6.050	6-3/16	4-1/2	-	
941322	6	6-5/8	7.390	6-5/32	5-1/2	-	
941370	6-1/4	6-5/8	7.390	6-9/32	5-1/2	-	
941325	8	8-5/8	9.625	8-1/8	8	-	
941328	10	10-3/4	11.750	10-1/4	10	-	
941331	12	12-3/4	14.000	12-5/32	12	-	
941405	6	6-5/8	7.390	6-5/32	4 (midget)	-	

- 14" through 24" shoes available

DRIVE SHOES

421 DRIVE SHOES

Features:

- 1/2 of shoe heat treated to 48-54 Rockwell "C" - hardness tested
- Highest quality seamless steel tube (to A.P.I. specs)
- Concentric machining assures straight setting in well
- Inside bevel on cable styled shoes radiused to allow drilling tools to be easily pulled back through shoe
- Zinc phosphate coated and painted to enhance appearance and corrosion-resistance
- Lead Free: ≤ .025% Lead Content



ROUGH BRASS
THREADED FITTINGS

Rotary Style - Threaded - Model 421RT

Part Number	Casing Nominal	Casing O.D.	Shoe O.D.	Shoe I.D.	Shoe Length	Thread Type	List Price Each
941378	2	2-3/8	2.875	2-3/32	3	11-1/2 NPS	See separate price list
941383	4	4-1/2	5.000	4-1/16	4-1/2	8 NPS	
941385	5	5-9/16	6.050	5-3/16	4-1/2	8 NPS	
941387	10	10-3/4	11.750	10-1/4	10	8 NPS	
941388	6	6-5/8	7.390	6-5/32	5-1/2	8 NPS	
941403	6	6-5/8	7.390	6-5/32	4 (midget)	8 NPS	

Rotary Style - Weld On - Model 421RW

Part Number	Casing Nominal	Casing O.D.	Shoe O.D.	Shoe I.D.	Shoe Length	Thread Type	List Price Each
941393	4	4-1/2	5.000	4-1/16	4	-	See separate price list
941394	5	5-9/16	6.050	5-3/16	4 1/2	-	
941391	6	6-5/8	7.390	6-5/32	5 1/2	-	
941400	6-1/4	6-5/8	7.390	6-9/32	6	-	
941407	6	6-5/8	7.390	6-5/32	4 (midget)	-	

Note: Contact factory for other sizes and availability.

DUAL ROTARY RING DRIVE SHOES

Features:

- Precision machined from domestic 4140 high alloy material, heat treated to high of 36RC
- Tungston carbide inserts press fit into the outside of shoe, improving hole cleaning and rate of penetration
- Milled pockets provide relief from residual stresses
- High stress areas are hard welded to 65RC to improve durability
- Manufactured in North America
- Available in 3" through 18" sizes



Part Number	Casing/Pipe Size (Inches)	Casing/Pipe Size (O.D.)	Weight (Lbs.)	List Price Each
941200	3*	3.5	3.5	See separate price list
941202	3.5*	4	3.7	
941204	4*	4.5	4.2	
941206	4.5*	5	4.4	
941208	5*	5.56	5	
*Bit O.D. is approximately 5/8" larger than pipe O.D. for 3" - 5". Tungsten Carbide buttons are 5/16" diameter for 3" - 6" pipes.				
941210	6**	6.625	6	
941214	8**	8.625	7.5	
941218	10**	10.75	9	
** Bit O.D. is approximately 3/4" larger than pipe O.D. for 6"-10". Tungsten Carbide buttons are 5/16" diameter for 8"-10" pipes.				
941222	12***	12.75	13	
941224	14***	14	16	
941226	16***	16	23	
941228	18***	18	26	
*** Bit O.D. is approximately 1" larger than pipe O.D. for 12"-14". Tungsten Carbide buttons are 7/16" diameter for 16"-18" pipes				

ECONOMY ROTARY RING DRIVE SHOES

Features:

- Machined of carbon steel
- Heat treated to 48-52 Rockwell C
- Induction hardened
- Manufactured in North America

Part Number	Casing/Pipe Size (Inches)	Casing/Pipe Size (O.D.)	Number of Buttons	Weight (Lbs.)	List Price Each
941236	6	6.625"	14	5	See separate price list
941240	8	8.625"	18	9	
941244	10	10.75"	22	11	
941248	12	12.75"	28	12	
941252	14	14"	32	13	
941256	16	16"	36	15	
941260	18	18"	40	17	
941264	20	20"	46	18	
941268	24	24"	54	22	



TUBULAR VALVES



460 PLUNGER

- Features:
- 2" and 2 1/2" tapped 3/8" NPT
 - 3" and 4" tapped 1/2" NPT
 - Utilizes (2) 711 cup leathers



460

Part Number	Well Size (Inches)	Description	Weight (Lbs.)	List Price Each
922492	2	460 Plunger Valve	1.3	See separate price list
922495	2-1/2	460 Plunger Valve	2.3	
922498	3	460 Plunger Valve	3.0	
922501	4	460 Plunger Valve	6.6	

461 CHECK

- Features:
- Ideal for well pumping and well development



461



479

Part Number	Well Size (Inches)	Description	Weight (Lbs.)	List Price Each
922381	2	461 Check Valve	1.3	See separate price list
922384	2-1/2	461 Check Valve	2.1	
922387	3	461 Check Valve	3.0	
922390	4	461 Check Valve	6.6	

479 BREMER CHECK

Part Number	Well Size (Inches)	Description	Weight (Lbs.)	List Price Each
922429	2	479 Bremer Check	1.3	See separate price list
922432	2-1/2	479 Bremer Check	2.0	
922435	3	479 Bremer Check	3.3	

TUBULAR VALVES
BRASS CYLINDERS

BRASS CYLINDERS



442 CYLINDER

- Features:
- Most popular closed top deep well cylinder
 - Barrel made of seamless brass tubing; caps and valves are all brass
 - Cylinder furnished with gravity poppets
 - More suitable for sandy wells than spring loaded valves
 - Recommended for small diameter wells where high capacity is desired
 - Strokes listed allow a clearance of 3 inches
 - Plungers are all brass, plain poppet, with two 711 cup leathers; the check poppet is fitted with a rubber facing.
 - Standard wall thickness .095 except 3" cylinder which is .128



442

Part Number	Inside Diameter & Stroke (Inches)	Barrel Length (Inches)	Length Overall (Inches)	Caps Tapped Pipe Size (Inches)	Size Rod in Plunger (Inches)	Smallest Well Cylinder Will Enter (Inches)	Capacity per Stroke (U.S. Gals.)	711 Cup Leather Hole (Inches)	Approx. Wt. Ea. (Lbs.)	List Price Each
920827	1-11/16 x 8	16	18	1	7/16	2	.080	1	4.0	See separate price list
920830	1-11/16 x 10	18	20	1	7/16	2	.100	1	4.5	
920833	1-11/16 x 12	20	22	1	7/16	2	.120	1	5.5	
920842	1-13/16 x 8	16	18	1	7/16	2	.089	1-3/16	4.6	
920845	1-13/16 x 10	18	20	1	7/16	2	.118	1-3/16	4.9	
920848	1-13/16 x 12	20	22	1	7/16	2	.134	1-3/16	5.2	
920857	2 x 8	16	18-1/2	1-1/4	7/16	2-1/2	.109	1-5/16	6.5	
920860	2 x 10	18	20-1/2	1-1/4	7/16	2-1/2	.136	1-5/16	7.0	
920863	2 x 12	20	22-1/2	1-1/4	7/16	2-1/2	.163	1-5/16	7.5	
920869	2-1/4 x 8	16	18-3/4	1-1/4	7/16	3	.138	1-1/2	7.8	
920872	2-1/4 x 10	18	20-3/4	1-1/4	7/16	3	.172	1-1/2	8.2	
920875	2-1/4 x 12	20	22-3/4	1-1/4	7/16	3	.205	1-1/2	8.7	
920881	2-1/2 x 8	16	19	1-1/4	7/16	3	.170	1-5/8	9.0	
920884	2-1/2 x 10	18	21	1-1/4	7/16	3	.213	1-5/8	9.4	
920887	2-1/2 x 12	20	23	1-1/4	7/16	3	.256	1-5/8	10.0	
920908	3 x 10	18	21-1/4	1-1/4	7/16	3-1/2	.306	2	12.3	

Note: On all 1-13/16 cylinders, .065 wall thickness is available

BRASS CYLINDERS



449 B CYLINDER

Features:

- Most popular open top deep well cylinder
- Furnished with three leather ball plungers
- Plunger bottom is tapped to screw onto check, enabling removal of both valves in one operation
- Standard size 706 cup leathers used on ball check valve
- Available with four leather plunger; price quoted at time of order
- 2-3/4" cylinders utilize 11 gauge barrel as standard
- Standard barrel is 13 gauge (0.95 wall) with optional 11 gauge (o.128 wall) barrel available at extra cost

Part Number	Inside Diameter & Stroke (Inches)	Length Overall (Inches)	Caps Tapped Pipe Size (Inches)		Size Rod in Plunger (Inches)	Smallest Well Cylinder Will Enter (Inches)	Capacity per Stroke (U.S. Gals.)	711 Cup Leather Hole Size (Inches)	Approx. Wt. Ea. (Lbs.)	List Price Each
			Top	Bottom						
922161	1-7/8 x 14	27-1/2	2	1-1/4	5/8	3	.167	1-1/4	10.8	See separate price list
922164	1-7/8 x 20	33-1/2	2	1-1/4	5/8	3	.238	1-1/4	12.0	
922167	1-7/8 x 26	39	2	1-1/4	5/8	3	.309	1-1/4	13.0	
922171	2-1/4 x 13	28	2-1/2	1-1/2	7/8	3-1/2	.224	1-1/2	13.8	
922176	2-1/4 x 25	40	2-1/2	1-1/2	7/8	3-1/2	.430	1-1/2	16.0	
922185	2-3/4 x 18	34	3	2	7/8	4	.463	1-7/8	21.0	
922188	2-3/4 x 24	40	3	2	7/8	4	.617	1-7/8	22.8	



449B

A-76 CYLINDER

Features:

- All brass cylinder suitable for heaviest duty in deepest well
- Furnished with 4-leather ball type plunger; ball check and rubber faced gravity check poppet

Part Number	Inside Diameter & Stroke (Inches)	Barrel Length (Inches)	Length Overall (Inches)	Caps Tapped Pipe Size (Inches)	Size Rod in Plunger (Inches)	Smallest Well Cylinder Will Enter (Inches)	Capacity per Stroke (U.S. Gals.)	711 Cup Leather Hole (Inches)	Approx. Wt. Ea. (Lbs.)	List Price Each
921198	2 x 12	24	27-1/4	1-1/4	7/16	2-1/2	.1632	1-5/16	10.3	



A-76

BRASS CYLINDERS
CYLINDERS

CYLINDERS

443 BRASS CYLINDER

Features:

- Open top brass cylinder with gravity valves to pump more water with less power
- Barrel furnished in .095 wall brass tubing with brass caps and 2 leather plunger
- Plunger bottom tapped to screw onto check, enabling removal of both valves in one operation
- Lead Free: ≤ .025% Lead Content

Part Number	Inside Diameter & Stroke (Inches)	Length Overall (Inches)	Caps Tapped Pipe Size (Inches)		Size Rod in Plunger (Inches)	Smallest Well Cylinder Will Enter (Inches)	Capacity per Stroke (U.S. Gals.)	711 Cup Leather Hole Size (Inches)	Approx. Wt. Ea. (Lbs.)	List Price Each
			Top	Bottom						
921726	1-13/16 x 12	20	2	1-1/4	5/8 - 11	3	.134	1-3/16	7.8	See separate price list
921735	2-1/4 x 14	24	2-1/2	1-1/2	5/8 - 11	3-1/2	.246	1-1/2	12	
921741	2-1/4 x 20	30	2-1/2	1-1/2	5/8 - 11	3-1/2	.352	1-1/2	13.8	
921750	2-3/4 x 18	30	3	2	5/8 - 11	4	.462	1-7/8	17	
921753	2-3/4 x 24	36	3	2	5/8 - 11	4	.617	1-7/8	18.8	
921768	3-3/4 x 18	30	4	3	1-1/8 - 7	6	.766	2-5/8	37	
921771	3-3/4 x 24	36	4	3	1-1/8 - 7	6	1.054	2-5/8	40	

NOTE: 2-1/4 available with 3/8" IPS plunger tapping. 2-3/4 available with 1/2" IPS tapping

450 EUREKA CYLINDER

Features:

- Designed for tubular wells, especially if original cylinder cannot be readily replaced
- Plunger is tapped to screw onto check, enabling removal of both valves in one operation
- Furnished with gravity poppets in plunger and check

Part Number	Size of Well (Inches)	Inside Dia. of Cylinder X Stroke (Inches)	Plunger Tapped for Pipe	Cup Leather Size in Hole Type 711		Capacity per Stroke (U.S. Gals.)	Approx. Wt. Ea. (Lbs.)	List Price Each
				Plunger (Inches)	Check (Inches)			
921223	2	1-13/16 x 10	3/8	1-13/16	1-13/16	.112	6	See separate price list
921225	2	1-13/16 x 14	3/8	1-13/16	1-13/16	.156	6.5	
921227	2-1/2	2-1/4 x 10	3/8	2-1/4	1-1/2	.172	9.5	
921229	2-1/2	2-1/4 x 14	3/8	2-1/4	1-1/2	.239	10.2	
921231	3	2-3/4 x 10	3/8	2-3/4	1-7/8	.257	12	
921233	3	2-3/4 x 14	3/8	2-3/4	1-7/8	.358	13	



443



450

ROD COUPLINGS



900

STEEL PUMP RODS

Features:

- Uniform, smooth finished, galvanized solid steel pump rods
- Pump Rod sold in bundles only

Part Number	Description	Size (Inches)	Length per Piece	Pieces per Bundle	Feet per Bundle	Weight per Bundle (Lbs.)	List Price Each
231000	Plain Ends	7/16	21 Ft.	10	210	108	See separate price list
941474	Threaded Both Ends	7/16	21 Ft.	10	210	108	
941488	Threaded & Coupled	7/16	21 Ft.	10	210	110	

ROD COUPLINGS



720

ROD COUPLINGS #720 FEMALE ROD TO FEMALE ROD

Part Number	Size (Inches)	Size of Hexagon (Inches)	Overall Length (Inches)	Pieces per Box	Approx. Weight per 100 Pieces (Lbs.)	List Price Each
930160	3/8 x 3/8	9/16	1-3/4	25	8.3	See separate price list
930163	7/16 x 3/8	5/8	1-3/4	25	11.6	
930166	7/16 x 7/16	5/8	1-3/4	25	10.2	
930169	1/2 x 3/8	11/16	1-3/4	Bulk	12.5	
930172	1/2 x 7/16	11/16	1-3/4	Bulk	11.8	
930175	1/2 x 1/2	11/16	1-3/4	25	11.8	
930181	5/8 x 7/16	13/16	2-1/8	Bulk	19.5	
930184	5/8 x 1/2	13/16	2-1/8	Bulk	17.0	
930187	5/8 x 5/8	13/16	2-1/8	Bulk	15.0	
930214	7/8 x 5/8	1-1/4	2-1/2	Bulk	42.0	
930220	7/8 x 7/8	1-1/4	2-1/2	Bulk	56.0	

ROD COUPLINGS

REDUCER COUPLINGS #585 MALE ROD TO FEMALE ROD

Part Number	Male X Female (Inches)	Pieces per Box	Approx. Weight per 100 Pieces (Lbs.)	List Price Each
930339	7/16 x 1/2	Bulk	14	See separate price list
930342	7/16 x 5/8	Bulk	20	
930348	7/16 x 7/8	Bulk	44	
930363	1/2 x 7/8	Bulk	42	
930372	5/8 x 7/16	Bulk	18	
930375	5/8 x 1/2	Bulk	18	
930384	5/8 x 7/8	Bulk	44	
930396	7/8 x 5/8	Bulk	40	



585

REDUCER COUPLINGS #586 MALE PIPE TO FEMALE ROD

Part Number	Male X Female (Inches)	Pieces per Box	Approx. Weight per 100 Pieces (Lbs.)	List Price Each
930426	3/8 x 7/16	Bulk	20	See separate price list
930429	3/8 x 1/2	Bulk	18	
930432	3/8 x 5/8	Bulk	28	
930450	1/2 x 5/8	Bulk	48	
930456	1/2 x 7/8	Bulk		



586

REDUCER COUPLINGS #587 FEMALE PIPE TO MALE ROD

Part Number	Male X Female (Inches)	Pieces per Box	Approx. Weight per 100 Pieces (Lbs.)	List Price Each
930480	3/8 x 7/16	Bulk	18	See separate price list
930486	3/8 x 5/8	Bulk	26	
930498	1/2 x 7/16	Bulk	30	
930500	1/2 x 1/2	Bulk	21	
930504	1/2 x 5/8	Bulk	40	
930510	1/2 x 7/8	Bulk	55	



587

ROD COUPLINGS
CYLINDER REPAIR PARTS

CYLINDER REPAIR PARTS

WINDMILL STUFFING BOX

Features:

- Stainless steel rod threaded 7/16 - 14 each end
- Adjustable packing nut



713

Part Number	Tapped for Pipe (Inches)	Rod Dimensions (Dia. X Length)	Approx. Weight per 100 Pieces (Lbs.)	List Price Each
923274	1-1/4	5/8" x 18"	3.75	See separate price list
923276	1-1/2	5/8" x 18"	4.0	
923284	2	3/4" x 24"	4.25	

PLUNGER RODS AND NUTS

Part Number	Size (Inches)	Description	List Price Each
924740	7/16 x 16	Brass Rod with Nut	See separate price list
924741	7/16 x 18	Brass Rod with Nut	
924744	7/16 x 14	Steel Rod with Nut (350)	
924746	7/16 x 16	Steel Rod with Nut	
924748	7/16 x 18	Steel Rod with Nut	

- Note: Plunger rod is 6" longer than the cylinder stroke

CYLINDER REPAIR PARTS

442 CYLINDER

Part Number	Description	ID (Inches)	List Price Each
621508	Barrel only, 16" long, .095 Wall	1-11/16	See separate price list
621558	Barrel only, 16" long, .095 Wall	1-13/16	
621658	Barrel only, 16" long, .095 Wall	2	
621708	Barrel only, 16" long, .095 Wall	2-1/4	
621758	Barrel only, 16" long, .095 Wall	2-1/2	
631208	Barrel only, 16" long, .128 Wall	3	
621510	Barrel only, 18" long, .095 Wall	1-11/16	
621560	Barrel only, 18" long, .095 Wall	1-13/16	
621660	Barrel only, 18" long, .095 Wall	2	
621710	Barrel only, 18" long, .095 Wall	2-1/4	
621760	Barrel only, 18" long, .095 Wall	2-1/2	
631210	Barrel only, 18" long, .128 Wall	3	
621512	Barrel only, 20" long, .095 Wall	1-11/16	
621562	Barrel only, 20" long, .095 Wall	1-13/16	
621662	Barrel only, 20" long, .095 Wall	2	
621712	Barrel only, 20" long, .095 Wall	2-1/4	
621762	Barrel only, 20" long, .095 Wall	2-1/2	
631212	Barrel only, 20" long, .128 Wall	3	
531800	Top Cap	1-11/16	See separate price list
531805	Top Cap	1-13/16	
531810	Top Cap	2	
531815	Top Cap	2-1/4	
531820	Top Cap	2-1/2	
531830	Top Cap	3	
924594	Bottom Cap with Check	1-11/16	
924595	Bottom Cap with Check	1-13/16	
924598	Bottom Cap with Check	2	
924599	Bottom Cap with Check	2-1/4	
924602	Bottom Cap with Check	2-1/2	
924603	Bottom Cap with Check	3	
924630	Plunger Complete	1-11/16	
924632	Plunger Complete	1-13/16	
924634	Plunger Complete	2	
924635	Plunger Complete	2-1/4	
924638	Plunger Complete	2-1/2	
924640	Plunger Complete	3	

450 CYLINDER

Part Number	Description	ID (Inches)	List Price Each
661500	Barrel only, 10" stroke	1-13/16	See separate price list
661520	Barrel only, 10" stroke	2-1/4	
661540	Barrel only, 10" stroke	2-3/4	
661505	Barrel only, 14" stroke	1-13/16	
661525	Barrel only, 14" stroke	2-1/4	
661545	Barrel only, 14" stroke	2-3/4	
701105	Spring Dog	1-13/16	
701110	Spring Dog	2-1/4	
701115	Spring Dog	2-3/4	
924950	Plunger, Complete	1-13/16	
924960	Plunger, Complete	2-1/2	
924965	Plunger, Complete	2-3/4	
924970	Check, Complete	1-13/16	
924980	Check, Complete	2-1/4	
924985	Check, Complete	2-3/4	

443 CYLINDER

Part Number	Description	ID (Inches)	List Price Each
631425	Barrel only, 20" long, .095 wall	2-1/4	See separate price list
621716	Barrel only, 24" long, .095 wall	2-1/4	
621722	Barrel only, 30" long, .095 wall	2-1/4	
631176	Barrel only, 20" long, .125 wall	2-3/4	
631500	Barrel only, 30" long, .125 wall	2-3/4	
631185	Barrel only, 36" long, .125 wall	2-3/4	
631475	Barrel only, 30" long, .125 wall	3-3/4	
631480	Barrel only, 36" long, .125 wall	3-3/4	
531905	Top Cap	2-1/4	
531910	Top Cap	2-3/4	
531915	Top Cap	3-3/4	
531755	Bottom Cap	2-1/4	
531760	Bottom Cap	2-3/4	
531765	Bottom Cap	3-3/4	
924190*	2L Plunger, Complete	2-1/4	
924192**	2L Plunger, Complete	2-3/4	
924196	2L Plunger, Complete	3-3/4	
924167	Check Complete	2-1/4	
924169	Check Complete	2-3/4	
924171	Check Complete	3-3/4	

* NOTE: Part #924190 - 2-1/4 - 2 Leather plunger has gravity poppet and 3/8" IPS tapping.

** NOTE: Part #924192 - 2-3/4 - 2 Leather plunger has gravity poppet and 1/2" IPS tapping.

CYLINDER REPAIR PARTS

449-B CYLINDER

Part Number	Description	ID (Inches)	List Price Each
621965	Barrel only, 24" long, .095 wall	1-7/8	See separate price list
621967	Barrel only, 30" long, .095 wall	1-7/8	
621969	Barrel only, 36" long, .095 wall	1-7/8	
621716	Barrel only, 24" long, .095 wall	2-1/4	
621728	Barrel only, 36" long, .095 wall	2-1/4	
631500	Barrel only, 30" long, .125 wall	2-3/4	
631185	Barrel only, 36" long, .125 wall	2-3/4	
631195	Barrel only, 48" long, .125 wall	2-3/4	
531900	Top Cap	1-7/8	
531905	Top Cap	2-1/4	
531910	Top Cap	2-3/4	
531750	Bottom Cap	1-7/8	
531755	Bottom Cap	2-1/4	
531760	BottomCap	2-3/4	
924930	3 Leather Ball Plunger	1-7/8	
924915	3 Leather Ball Plunger	2-1/4	
924917	3 Leather Ball Plunger	2-3/4	
924920	Ball Check, Complete	1-7/8	
924804	Ball Check, Complete	2-1/4	
924808	Ball Check, Complete	2-3/4	

456 CYLINDER

Part Number	Description	ID (Inches)	List Price Each
651420	Barrel only, 24" long	2-1/4	See separate price list
925616	2 Leather Plunger	1-13/16	
925620	2 Leather Plunger	2-1/4	
925610	Check, Complete	1-13/16	
925614	Check, Complete	2-1/4	

652B CYLINDER

Part Number	Description	ID (Inches)	List Price Each
651420	Barrel only, 24" long	2-1/4	See separate price list
651410	Barrel only, 30" long	2-1/4	
651430	Barrel only, 36" long	2-1/4	
651440	Barrel only, 36" long	2-3/4	
651445	Barrel only, 42" long	2-3/4	
924915	3 Leather Plunger, Ball	2-1/4	
924917	3 Leather Plunger, Ball	2-3/4	
924800	Check Complete, Ball	1-13/16	
924804	Check Complete, Ball	2-1/4	
924808	Check Complete, Ball	2-3/4	

A-76 CYLINDER

Part Number	Description	ID (Inches)	List Price Each
621262	Barrel only, 20" long	1-3/4	See separate price list
621266	Barrel only, 24" long	1-3/4	
621666	Barrel only, 24" long	2	
925705	Bottom Cap with Check	1-3/4	
925710	Bottom Cap with Check	2	
925695	Plunger, Complete	1-3/4	
925700	Plunger, Complete	2	

CUP LEATHERS



Features:

No. 702

- Oak tanned leather - not treated
- Rough textured side out

No. 706

- Oaktan leather and carnuba wax
- Top quality cups
- Extraordinary strength of fiber and splendid wearing quality

No. 707

- Graphite treated
- Call for price and availability

No. 711

- Oaktan leather
- Especially soft and flexible after waterproofing
- A frictionless cup leather
- Made of highest grade leather stock available

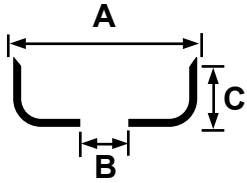

Part Number	Model	A Cylinder ID (Inches)	B Hole Size (Inches)	C Height (Inches)	Weight per 100 Pieces (Lbs.)	List Price Each
940265	702	2	1-5/16	3/4	3	
940556	706	1-1/4	5/8	1/2	1-1/4	
940598	706	1-13/16	1-3/16	3/4	2-1/2	
940600	706	1-7/8	1-1/4	3/4	2-1/2	
940607	706	2	5/8	3/4	3	
940613	706	2	1-5/16	3/4	3	
940631	706	2-1/4	1-1/2	3/4	3-1/2	
940640	706	2-1/2	1-5/8	13/16	4	
940646	706	2-3/4	1-7/8	13/16	4-3/4	
940652	706	3	2	13/16	6	
940679	706	4	3	1-1/16	11	
940735	711	1	3/8	7/16	3/4	
940769	711	1-1/4	3/8	1/2	1-1/4	
940772	711	1-1/4	7/16	1/2	1-1/4	
940775	711	1-1/4	1/2	1/2	1-1/4	
940778	711	1-1/4	5/8	1/2	1-1/4	
940793	711	1-3/8	3/8	5/8	1-1/2	
940796	711	1-3/8	1/2	5/8	1-1/2	
940805	711	1-1/2	3/8	5/8	1-3/4	
940808	711	1-1/2	7/16	5/8	1-3/4	
940811	711	1-1/2	1/2	5/8	1-3/4	
940814	711	1-1/2	5/8	5/8	1-3/4	
940826	711	1-5/8	5/8	5/8	2	
940844	711	1-11/16	1	5/8	2-1/8	
940857	711	1-11/16	5/8	5/8	2-1/8	
940859	711	1-3/4	1-1/8	11/16	2-1/4	
940880	711	1-13/16	1-3/16	3/4	2-1/2	
940892	711	1-7/8	1-3/16	3/4	2-1/2	
940898	711	1-7/8	1-1/4	3/4	2-1/2	
940919	711	2	5/8	3/4	3	
940922	711	2	1-1/4	3/4	3	
940925	711	2	1-5/16	3/4	3	
940967	711	2-1/4	1-3/8	3/4	3-1/2	
940970	711	2-1/4	1-1/2	3/4	3-1/2	
940994	711	2-1/2	5/8	13/16	4	
941000	711	2-1/2	1-5/8	13/16	4	
941015	711	2-3/4	1-7/8	13/16	4-3/4	
941025	711	3	1-1/2	13/16	5	
941029	711	3	1-7/8	13/16	6	
941030	711	3	2	13/16	6	
941051	711	3-1/2	2-1/2	1	7-1/4	
941055	711	3-3/4	2-5/8	1	8	
941066	711	4	3	1 1/16	11	

See separate price list

• All leathers packed and sold in boxes of 12.

CUP LEATHERS

CUP LEATHERS/REPAIR PARTS



700 CYLINDER LEATHERS

- Lower value leather
- Oak tanned leather

Part Number	Model	Cylinder ID (Inches)	Outside Dia. (Inches)	List Price Each
941177	700	2	2-1/2	See separate price list
941180	700	2-1/2	2-3/4	
941183	700	2-1/2	3	
941186	700	2-3/4	3-1/4	
941189	700	3	3-1/2	



• All leathers packed and sold in boxes of 12.

NEOPRENE CUP

- Reinforced fabric base
- High flared lip
- Extremely pliable

Part Number	Cylinder ID (Inches)	Outside Dia. (Inches)	List Price Each
941114	1-7/8	1-1/4	See separate price list
941115	2	1-5/16	
941113	2-1/4	1-3/8	
941116	2-1/2	1-5/8	
941117	2-3/4	1-7/8	
941118	3	2	



REPAIR PARTS

540 IRON FOOT VALVE

Part Number	Valve Size (Inches)	Description	Finish	List Price Each
542910	1-1/2	Strainer	Painted	See separate price list
542915	2	Strainer	Painted	
542925	3	Strainer	Painted	
542930	4	Strainer	Painted	
542940	6	Strainer	Painted	
442505	1-1/2	Seat Plate		
442510	2	Seat Plate		
442520	3	Seat Plate		
442525	4	Seat Plate		
442535	6	Seat Plate		
712715	1-1/2	Valve Leather Assembly		
712720	2	Valve Leather Assembly		
712730	3	Valve Leather Assembly		
712735	4	Valve Leather Assembly		
712745	6	Valve Leather Assembly		
941183	1-1/2	Leather only		
482720	2	Leather only		
482730	3	Leather only		
482735	4	Leather only		
482740	5	Leather only		
482745	6	Leather only		

#2 PITCHER PUMP

Part Number	Description	List Price Each
940083	Plunger complete with rod	See separate price list
940084	Plunger Rod	
940097	Bottom check assembly	

CUP LEATHERS/REPAIR PARTS

YARD HYDRANTS

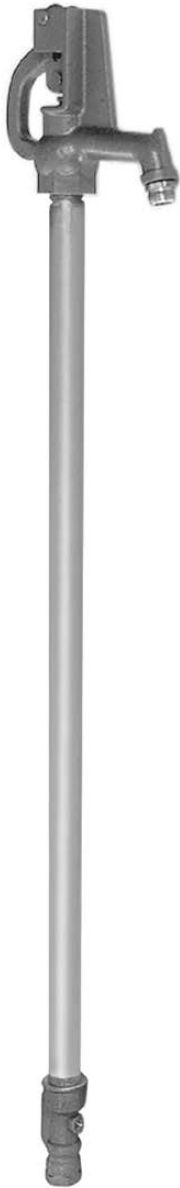

Features:

- Provides running water all year for farms, homes and industry despite freezing temperatures. 3/4" inlet on brass valve.
- Standard 3/4" brass hose thread adapter on the outlet, and can be removed to connect 1/2" pipe.
- All hydrants are 27" from ground to outlet above the bury depth, using 1" I.D. galvanized steel pipe.
- Hydrant is designed with shut-off valve below frost line. Will not freeze as pipe drains through a bleeder. Brass nozzle is threaded for standard 3/4" garden hose coupling. 7/16" valve rod operates valve below frost line, allowing water to flow even in sub-zero weather. If water leaks at packing nut when hydrant is in operation, tighten nut or replace packing if necessary.

Part Number	Model Number	1" I.D. Pipe Size & Bury Length	Weight Each (Lbs.)	List Price Each
935401	5401	1 ft.	13-1/3	See separate price list
935402	5402	2 ft.	15-1/2	
935403	5403	3 ft.	17-1/2	
935404	5404	4 ft.	19-1/2	
935405	5405	5 ft.	21-1/2	
935406	5406	6 ft.	23-1/2	
935407	5407	7 ft.	25-1/2	
935408	5408	8 ft.	27-1/2	

HYDRANT REPAIR PARTS

Part Number	Model Number	Description	List Price Each
932901	G-1	Head Casting	See separate price list
932903	G-6	Brass Hose	
932910	G-10	Thread Adapter	
932918	G-15	Lever Casting	
932920	G-20	Lever Bolt	
932921	G-25	Draw Straps	
932927	G-30	Pivot Connector & Nuts	
932930	G-35	Packing Nut	
932940	G-40	Valve Stem Packing	
932941	G-45	Valve Body	
932942	G-50	Operating Rod (SS) Brass Reducer	
	G-55	Operating Stem (7/16" Galv. Rod)	
	G-60	1" Galvanized Pipe	
932945	G-65	Brass Plunger Bushing	
932946	G-70	Brass Plunger Body	
932947	G-75	Brass Plunger Bolt	
932950	G-80	Brass Threaded Washer	
932985	G-85	Rubber Seat Washer (Std. Bibb)	
932986	G-90	Stainless Steel Plunger Spring	
932987	G-100	Retainer Screw for Rubber	
932905	G-105	Cup Leathers	
932988	G-110	Brass Washers for Plunger	
932915	G-115	Plunger Assembly	
932989	G-120	Head Assembly	

G-115 consists of Parts No. G-65, G-70, G-75, G-80, G-85, G-90, G-100, G-105 and G-110.

YARD HYDRANTS
MONITORING & REMEDIATION
ADAPTERS

UNIVERSAL HYDRANT "DRAIN BOX"



Features:

- Eliminates gravel pack
- Provides drainage away from valve body
- External louvers retain soil from entering upper valve body
- Openings on sides and bottom allows water to percolate into ground
- Drainage equivalent to nine square feet of washed gravel, six inches thick
- 100% Recycled Material

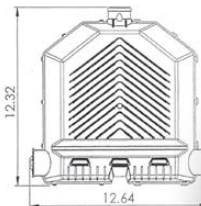

Any bury depth frost-free hydrant

Hose Clamp X3

Drain Orifice

Water Drain Louvers

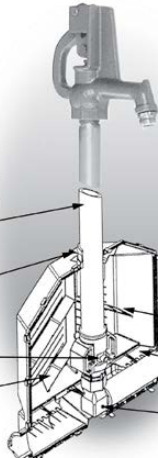

Locking Tabs

Structural Ribs

Soil Impediment plate

T or 90° Connector

Part Number	Weight	List Price Each
935350	2.0#	See separate price list

Includes 3 clamps



dicken™ PITLESS ADAPTERS

Features:

- Ideal for use in remediation wells
- Precision machined all red brass castings with viton o'rings
- Brass insert is electroless nickel plated to resist harsh environment and contamination
- Wrench grip on ell speeds installation
- Large inner and outer gasket to seal out surface water contamination
- Built-in lowering eyelet for easier installation
- Pressure Tested to 150 PSI



Part Number	Model	Discharge Pipe (Inches)	Supply Pipe (Inches)	Casing Size (Inches)	Hole Size (Inches)	Shipping Weight (Lbs.-Oz.)	Working Load (Lbs.)	List Price Each
952111	LD-S-10-N	1	1	5 to 12	1-3/4	4-8	2000	See separate price list
952113	LD-S-12-N	1-1/4	1-1/4	5 to 12	2-1/4	5-8	2000	
952021	S-20-N	2	2	5-5/8 to 12	3-1/8	14-4	5000	

NOTE: All stainless steel adapters available for leachate applications

MAASS™ MODEL JN SERIES OF PITLESS ADAPTERS AND UNITS

All Feature:

- Ideal for remediation wells
- Water contacts only 304 stainless steel nipple and electroless nickel plated brass insert
- No obstruction left in well when insert is pulled
- Viton "O" rings standard
- Tapered 8 degree slip fitting for easy installation and removal of electroless nickel plated brass insert
- 304 stainless steel guide pins standard

MAASS™ MODEL JN WELD-ON PITLESS ADAPTERS

Features:

- Permanently installed by welding for increased strength and durability

Part Number	Model	Discharge Pipe (Inches)	Drop Pipe (Inches)	I.D. Casing Size (Inches)	Weight (Lbs.)	List Price Each
928101	4J1 N	1	1	4-5	6	See separate price list
928121	6J1 N	1	1	6-7-8+	6	
928106	4J1-1/4 N	1-1/4	1-1/4	4-5	7	
928126	6J1-1/4 N	1-1/4	1-1/4	6-7-8+	7	
928136	6J2 N	2	2	6-7-8+	12	
928146	8J3 N	3	3	8-10-12+	32	



MAASS™ MODEL JCN CLAMP-ON PITLESS ADAPTERS

Features:

- Ideal for use on either plastic or steel well casing
- 304 stainless steel clamps and nuts
- Electroless nickel plated brass insert and Viton "O" rings standard

Part Number	Model	Discharge Pipe (Inches)	Drop Pipe (Inches)	O.D. Casing Size (Inches)	Standard Clamp-on Weight	List Price Each
928302	4JC1 N	1	1	4-1/2	11.0	See separate price list
928307	5ODJC1 N	1	1	5	11.0	
928312	5JC1 N	1	1	5-9/16	11.0	
928322	6JC1 N	1	1	6-5/8	11.75	



MAASS™ MODEL JD ADAPTER

Features:

- 304 stainless steel construction
- Viton gasket for inner and outer casing seal
- Insert and housing have 8 degree taper for easy installation and removal
- Extended length nipple on housing to allow adapter to fit from 1/4" to 2" thick wall pipe
- Viton "O" ring seal

Part Number	Model	Discharge Pipe NPT	Discharge Length (Inches)	Drop Pipe	Casing Size Min.	Max Pump O.D.	Weight (Lbs.)	List Price Each
928930	JD1 SS JD1	1"	4"	1"	6"	4"	4.75	See separate price list
928932	1/4 SS JD1	1-1/4"	4"	1-1/4"	6"	4"	5.12	
928934	1/2 SS JD2	1-1/2"	4"	1-1/2"	6"	4"	7.2	
928936	SS	2"	4"	2"	8"	6"	10.2	
928956	JD2 SS-6	2"	3-1/2"	2"	6"	4"	10.5	
928960	JD3 SS-8	3"	4-1/4"	3"	8"	4"	30.0	
928940	JD3 SS	3"	5"	3"	10"	6"	30.2	



MONITORING & REMEDIATION ADAPTERS
PVC SCREENS & RISER PIPES

PVC SCREENS & RISER PIPES



PVC FLUSH JOINT SCREEN

Features:

- Schedule 40
- Meets specifications ASTM D-2665 and D-1785
- 10 Slot
- Type 1 grade 1 PVC material specifically ASTM D-1784
- Box quantity 16 pcs.
- Flush joint threads meet ASTM F480-88A

Part Number	Model Number	Size O.D.	Screen Length	Type	List Price Each
917501	FJMBP42	2"	60"	Point	See separate price list
917503	FJBP2	2"	60"	Plug	
917505	FJTC2	2"	60"	Cap	



PVC FLUSH JOINT RISER PIPE

Features:

- Schedule 40
- Box quantity 16 pcs.

Part Number	Size O.D.	Length	List Price Each
917520	2"	60"	See separate price list



PVC FLUSH JOINT SCREEN

Features:

- Schedule 80
- Meets specifications ASTM D-2665 and D-1785
- 10 Slot
- Type 1 grade 1 PVC material specifically ASTM D-1784
- Box quantity 16 pcs.
- Flush joint threads meet ASTM F480-88A

Part Number	Model Number	Size O.D.	Screen Length	Type	List Price Each
917550	FJMBP42	2"	60"	Point	See separate price list
917552	FJBP2	2"	60"	Plug	
917554	FJTC2	2"	60"	Cap	

PVC FLUSH JOINT RISER PIPE

Features:

- Schedule 80
- Box quantity 16 pcs.

Part Number	Size O.D.	Length	List Price Each
917600	2"	60"	See separate price list

Note: All screens and risers individually sealed in 6 mil plastic.

MONITORING & REMEDIATION ACCESSORIES



MIDWEST-DICKEN™ WELD PROCESS MONITOR WELL POINT

Features:

- Points will not easily collapse while being driven
- Rugged design with octagonal electroless nickel plated head to prohibit turning in tough driving
- Easily extended in the field by removing head and coupling together with second well point for added capacity
- Stainless steel mig weld top and bottom to prohibit jacket shift or peeling
- 3/16" Diameter spotweld on 1" centers to prevent seam opening
- Stainless steel jacketed 1/8" staggered perforations for maximum open area
- Available in 60-80-100 mesh stainless steel gauze for long life screening
- Point may be driven or used with hollow stem flight auger
- Other custom lengths and styles available

NOTE: 1-1/4" WELL POINT HAS 2" O.D., 2" WELL POINT HAS 3" O.D.

STAINLESS STEEL

Part Number	Model Number	Gauze	Pipe Size	Pipe Lg. X Jacket	Weight (Lbs.)	List Price Each
918000	SS90M	60	1-1/4	24 x 18	6	See separate price list
918005	SS90M	80	1-1/4	24 x 18	6	
918010	SS94M	60	1-1/4	30 x 24	7	
918015	SS94M	80	1-1/4	30 x 24	7	
918020	SS98M	60	1-1/4	36 x 30	8	
918025	SS98M	80	1-1/4	36 x 30	8	
918030	SS100M	60	1-1/4	42 x 36	10	
918035	SS100M	80	1-1/4	42 x 36	10	
918040	SS102M	60	1-1/4	48 x 42	11	
918045	SS102M	80	1-1/4	48 x 42	11	
918050	SS110M	60	1-1/4	60 x 54	13	
918055	SS110M	80	1-1/4	60 x 54	13	
918060	SS164M	60	2	30 x 24	12	
918065	SS164M	80	2	30 x 24	12	
918070	SS168M	60	2	36 x 30	14	
918075	SS168M	80	2	36 x 30	14	
918080	SS172M	60	2	48 x 42	18	
918085	SS172M	80	2	48 x 42	18	
918090	SS176M	60	2	60 x 54	22	
918095	SS176M	80	2	60 x 54	22	



OPEN END WELL SCREEN

Features:

- Manufactured entirely of stainless steel
- Provides additional capacity when coupled with a well point

Part Number	Model Number	Gauze	Pipe Size	Pipe Lg. X Jacket	Weight (Lbs.)	List Price Each
918200	SS99M	60	1-1/4	36 x 30	7	See separate price list
918210	SS99M	60	2	36 x 30	11	
918205	SS99M	80	1-1/4	36 x 30	7	
918215	SS99M	80	2	36 x 30	11	



DRIVE COUPLINGS ELECTROLESS NICKEL PLATED

Part Number	Pipe Size	Approx. Weight (Lbs.)	Quantity per Box	List Price Each
941590	1-1/4	1.0	25	See separate price list
941592	2	1.5	15	See separate price list

MAASS™ LOCKING WELL CAP

Features:

- Moderate cost with corrosion resistant cast aluminum
- Suitable for use on monitoring wells
- Protection against vandalism
- Easy to install Drill one hole for bolt to hold cap in place Bolt cap down Lock padlock on cap

Part Number	Model Number	O.D. Casing Size (Inches)	Description	List Price Each
952770	4LCS	4-1/2	Submersible	See separate price list
952772	5LCS	5-9/16	Submersible	
952774	6LCS	6-5/8	Submersible	
952776	8LCS	8-3/4	Submersible	
952769	LJ2	PADLOCK FOR CAPS - ALL KEYED ALIKE		



304 STAINLESS STEEL MALE ADAPTERS

Part Number	Trade Number	Pipe Size (Inches)	Approx. Weight per 100 (Lbs.)	List Price Each
406520	MASS-2	1/2	15	See separate price list
406523	MASS-3	3/4	22	
406526	MASS-4	1	35	
406529	MASS-5	1-1/4	52	
406532	MASS-8	2	92	



KWIK-ZIP® CENTRALIZERS

Features:

- Centralizers manufactured from high strength inert thermoplastic
- Size by adding more segments forming a complete centralizer
- Service temperatures from -4° to 176° Fahrenheit
- Three ranges to fit pipe diameters 3/4" to 30"+



GT

GT SERIES (Pipe Diameter from 3/4" to 2-9/16")

Features:

- No metal parts
- Bow spring height/stand-off from 0.79" to 1.57"
- Excellent for vapor sampling, monitoring and micro sampling wells
- Also used on small diameter drop pipe, rock bolts, soil nails, and anchors
- Easily installed with pliers

Part Number	Model Number	Bow Spring Height	Box Qty.	List Price Each
933090	GT20-1	0.79"	100	See separate price list
933095	GT30-1	1.18"	100	
933100	GT40-1	1/57"	100	

Qty. of segments required per centralizer		
Approx. Bar/Pipe Diameter	Series	Segments
From 3/4" to 1-1/8"		2
From 1-1/8" to 1-13/16"		3
From 1-13/16" to 2-9/16"		4



155 HT



380 HT

155 HT & 380 HT SERIES (Pipe Diameter from 2.3" to 30")

Features:

- No metal parts
- Bow spring height / stand-off from 1.18" to 2" (will deflect to 0.59" for bore holes)
- Excellent for all types and gravel packed screens
- Easily installed with FT 155 or FT 380 Fastening Tool Kit

Part Number	Model Number	Bow Spring Height	Box Qty.	List Price Each
933105	155HT-D	1.18"	30	See separate price list
933110	155HT-E	2.0"	30	
933135	380 HT-D	1.18"	50	See separate price list
933140	380 HT-E	2.0"	50	

Qty. of segments required per centralizer		
Approx. Pipe Diameter	Series	Segments
From 2.3" to 3.75"	155 HT	2
From 3.75" to 5.565"	155 HT	3
From 5.565" to 6.625"	155 HT	4
From 6.625" to 8.625"	380 HT	2
From 8.625" to 13.375"	380 HT	3
From 13.375" to 18"	380 HT	4
From 18" to 22"	380 HT	5
From 22" to 27"	380 HT	6
From 27" to 30"	380 HT	7

CENTRALIZERS

KWIK-ZIP® 155 & 380 SERIES FASTENING TOOL KIT

Features:

- Heavy duty cast stainless steel jaws
- Used to tighten last joint when segments are fixed to casing
- Rubber handle grips
- Trimming clips are also provided with fastening tool kit



Part Number	Model Number	Weight (lbs.)	List Price Each
933175	FT155	3.4	See separate price list
933180	FT380	4.4	

HD SERIES (Pipe Diameter from 4.33" to 62.99")

Features:

- No metal parts
- Rapid on site assembly with a flat 5/16" screwdriver
- Rubber pads provide maximum grip to pipe surge
- Holds casing center of bore hole for positive grouting, gravel packing and screen installation



Part Number	Model Number	Bow Spring Height	Box Qty.	List Price Each
933200	HD 30	1-3/16"	30	See separate price list
933205	HD 50	2"	30	
933210	HD 75	3"	30	

Qty. of segments required per centralizer		
Approx. Pipe Diameter	Series	Segments
4.33" to 6.30"	HD	2
6.00" to 8.62"	HD	3
9.84" to 12.75"	HD	4
14.00"	HD	5
16.00" to 18.00"	HD	6
20.00"	HD	7
24.00"	HD	8

STAINLESS STEEL CENTRALIZERS

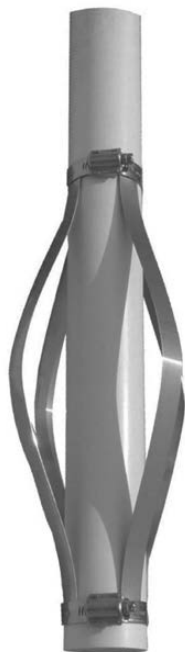

Features:

- All stainless construction
- Easily installed by simply tightening stainless worm drive clamps
- Strap width 3/4"
- Strap thickness 0.25
- Strap material 301 stainless steel coiled strip steel

Part Number	Drop Pipe Size	Maximum Bore Hole/Casing Diameter	List Price Each
933005	2"	12"	See separate price list
933010	2-1/2"	12"	
933015	3"	13"	
933020	4"	16"	
933025	4-1/2"	16".5	
933030	5"	17"	
933035	6"	18"	
933040	8"	22"	
933045	10"	24"	
933050	12"	26"	

NOTE: Standard strap length on 2" through 5" drop pipe centralizers is 15".
Standard strap length on 6" through 12" drop pipe centralizers is 18"

Please contact factory for custom applications

WELL BUSTER™ Flowing Artesian Well Packer

Features:

- Designed for flowing artesian wells
- Can be used with submersible pump applications
- Unique expandable rubber packer design
- All metal materials SS304
- Strong sealed wire connectors
- Has 4 #10AWG wires sealed in unit for attaching pump wires
- Eight clear, Maass Midwest 14-10 Heat Shrinks included
- Air release valve stops sand from being drawn into well from vacuum
- Well Buster is installed above Pitless Adapter

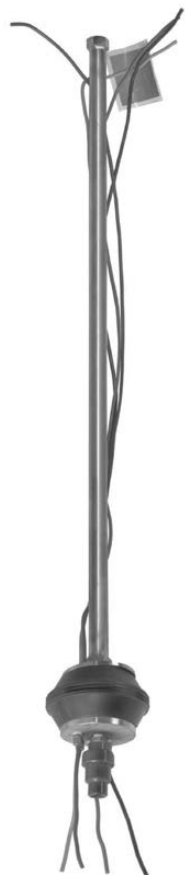

Part Number	Casing Size I.D.	Bury Depth	Weight (Lbs.)	List Price Each
935611	4-1/2"	4'	12.0	See separate price list
935613	4-1/2"	5'	12.5	
935615	4-1/2"	6'	13.0	
935628	5"	4'	12.0	
935630	5"	5'	12.5	
935632	5"	6'	13.0	
935638	6"	4'	12.0	
935640	6"	5'	12.5	
935642	6"	6'	13.0	
935648	6-1/4"	4'	12.0	
935650	6-1/4"	5'	12.5	
935652	6-1/4"	6'	13.0	
935656	8"	4'	17.0	
935658	8"	5'	17.5	
935660	8"	6'	18.0	

NOTE: Contact factory for other bury depths.
5" I.D. wells, 30 psi maximum;
6" and 6 1/4" I.D. wells, 20 psi maximum

REPLACEMENT AIR VALVE

Part Number	List Price Each
930636	See separate price list

**STAINLESS STEEL CENTRALIZERS
WELL BUSTER™ WEL PACKER**

TECHNICAL INFORMATION

To obtain the capacity of a pump with diameter of cylinder given in table, but with a stroke longer than 24 inches, add or multiply the capacity to represent the required length of stroke.

To obtain the amount of water discharged per minute, multiply the capacity per stroke by the number of strokes per minute. To obtain the amount of water discharged per hour, multiply this figure by 60.

WATER DISCHARGED PER STROKE BY SINGLE ACTION CYLINDERS

Pump Cylinder Diameter (Inches)	Length of Stroke in Inches with Capacity per Stroke in Gallons											Pump Cylinder Area of Circle (Square Inches)	
	1	2	3	4	5	6	7	8	10	12	18		24
1-3/8	.0064	.0128	.0192	.0256	.0320	.0384	.0448	.0512	.0640	.0768	.1152	.1536	1.4849
1-1/2	.0076	.0153	.0229	.0306	.0382	.0459	.0535	.0612	.0765	.0918	.1375	.1832	1.7671
1-5/8	.0090	.0180	.0270	.0360	.0450	.0540	.0630	.0720	.0900	.1080	.1620	.2140	2.0739
1-3/4	.0104	.0208	.0312	.0416	.0512	.0625	.0729	.0833	.1041	.1249	.1872	.2497	2.4053
1-13/16	.0112	.0224	.0336	.0448	.0560	.0672	.0784	.0896	.1120	.1344	.2016	.2688	2.5802
1-7/8	.0120	.0240	.0360	.0480	.0600	.0720	.0840	.0960	.1200	.1440	.2160	.2880	2.7612
1-31/32	.0132	.0263	.0395	.0527	.0659	.0790	.0922	.1054	.1317	.1580	.2371	.3161	3.0440
2	.0136	.0272	.0408	.0544	.0680	.0816	.0952	.1088	.1360	.1632	.2448	.3264	3.1416
2-3/16	.0163	.0325	.0488	.0650	.0812	.0976	.1137	.1300	.1625	.1952	.2928	.3904	3.7584
2-1/4	.0172	.0344	.0516	.0688	.0860	.1033	.1205	.1377	.1721	.2071	.3104	.4137	3.9760
2-1/2	.0212	.0425	.0637	.0850	.1062	.1275	.1487	.1700	.2125	.2550	.3825	.5100	4.9070
2-3/4	.0257	.0514	.0771	.1028	.1285	.1543	.1800	.2057	.2571	.3085	.4628	.6171	5.9395
3	.0306	.0612	.0918	.1224	.1530	.1836	.2142	.2448	.3060	.3672	.5508	.7344	7.0686
3-1/4	.0359	.0719	.1078	.1438	.1795	.2156	.2515	.2875	.3594	.4313	.6469	.8625	8.2957
3-1/2	.0416	.0833	.1249	.1666	.2082	.2499	.2915	.3332	.4165	.4998	.7497	.9996	9.6211
3-3/4	.0479	.0957	.1435	.1914	.2393	.2871	.3350	.3828	.4785	.5743	.8614	1.1485	11.044
4	.0544	.1088	.1632	.2176	.2720	.3264	.3808	.4352	.5440	.6528	.9792	1.3056	12.566
4-1/4	.0614	.1228	.1842	.2457	.3070	.3685	.4299	.4913	.6141	.7370	1.1054	1.4739	14.186
4-1/2	.0688	.1377	.2065	.2754	.3442	.4131	.4819	.5508	.6885	.8262	1.2393	1.6524	15.904
4-3/4	.0767	.1534	.2301	.3068	.3835	.4602	.5369	.6136	.7670	.9204	1.3806	1.8408	17.721
5	.0850	.1700	.2550	.3400	.4250	.5100	.5950	.6800	.8500	1.0200	1.5300	2.0400	19.635
5-1/2	.1028	.2057	.3085	.4114	.5142	.6171	.7199	.8228	1.0285	1.2342	1.8513	2.4684	23.758
5-3/4	.1124	.2248	.3372	.4496	.5620	.6744	.7868	.8992	1.1240	1.3488	2.0232	2.6976	25.967

Capacities are given in U.S. gallons.

WEIGHT LOAD FACTORS

Approximate Weight of Water* and Pipe per Foot

Type of Drop Pipe	Nominal Size of Pipe (Inches)	Pipe ID (Inches)	Water Volume per Foot (Cu. In.)	Approx. Water Weight per Foot (Lbs.)	Approx. Pipe Weight per Foot (Lbs.)	Approx. Total Weight per Foot (Lbs.)
160 PSI Polyethylene	1	1.049	10.37	0.38	0.26	0.64
	1-1/4	1.380	17.95	0.65	0.43	1.08
Schedule 80 PVC	1	0.957	8.63	0.31	0.40	0.71
	1-1/4	1.278	15.39	0.56	0.55	1.11
	1-1/2	1.500	21.21	0.77	0.66	1.43
	2	1.939	35.43	1.28	0.92	2.20
Schedule 40 Steel Pipe	1	1.049	10.37	0.38	1.68	2.06
	1-1/4	1.380	17.95	0.65	2.28	2.93
	1-1/2	1.610	24.43	0.88	2.73	3.61
	2	2.067	40.27	1.45	3.68	5.13

*One Cubic Foot Water = 62.4 Lbs. One Cubic Inch Water = .036 Lbs.

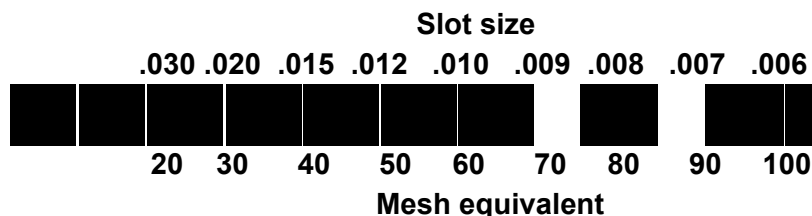

INSTALLATION INFORMATION

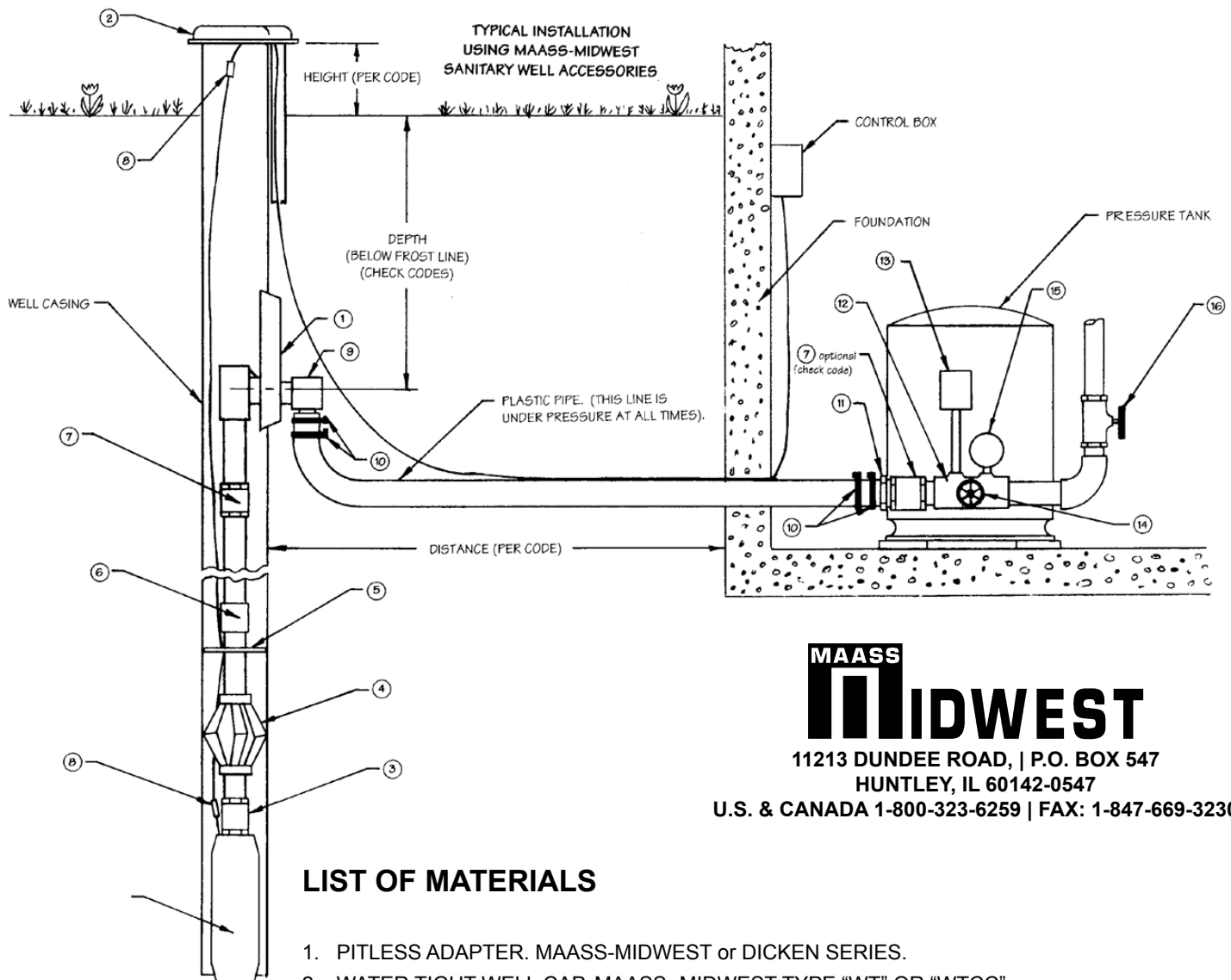

**MAASS
MIDWEST**

11213 DUNDEE ROAD, | P.O. BOX 547
HUNTLEY, IL 60142-0547

U.S. & CANADA 1-800-323-6259 | FAX: 1-847-669-3230

LIST OF MATERIALS

1. PITLESS ADAPTER. MAASS-MIDWEST or DICKEN SERIES.
2. WATER TIGHT WELL CAP. MAASS- MIDWEST TYPE "WT" OR "WTCC".
3. CHECK VALVE. MAASS-MIDWEST TYPE 529.
4. TORQUE ARRESTOR. MAASS-MIDWEST TYPE STA-48.
5. CABLE GUARD. MAASS-MIDWEST TYPE 90110. (ONE REQUIRED EVERY 10 FEET).
6. COUPLING. MAASS-MIDWEST TYPE 11P (PVC).
7. CHECK VALVE. MAASS-MIDWEST TYPE 530 or TYPE 531.
8. MAASS-MIDWEST HEAT SHRINK SPLICE KIT.
9. MAASS-MIDWEST RED BRASS INSERT FITTING.
10. STAINLESS STEEL PIPE CLAMPS. MAASS-MIDWEST 225 SERIES.
11. RED BRASS MALE ADAPTER. MAASS- MIDWEST TYPE "MA".
12. RED BRASS TANK TEE. MAASS- MIDWEST TYPE "TFB" or "TCB".
13. PRESSURE SWITCH. MAASS-MIDWEST TYPE "FSG".
14. MAASS-MIDWEST BRASS BOILER DRAIN VALVE.
15. MAASS-MIDWEST STEEL CASED PRESSURE GAUGE.
16. MAASS-MIDWEST BRASS GATE VALVE.

NOTE: Local codes and practices may vary. Check before installing the water system. This diagram is for general illustration purposes only. No warranties, expressed or implied, are conveyed regarding the accuracy or application of the information herein.